

# INFINITY<sup>®</sup> SYSTEM



**DS120**

**A Patented Pressure-Equalized Rainscreen Exterior Insulation and Finish System That Incorporates Continuous Insulation and An Air/Water-Resistive Barrier**

## **Infinity Installation Details**

# TABLE OF CONTENTS

## DETAIL

INFINITY SYSTEM	IS 0.0.01
BUILDING FACADE	IS 0.0.02
I.S. INSULATION BOARD™ LAYOUT	IS 0.0.03
OUTSIDE CORNER	IS 0.0.04
- I.S. INSULATION BOARD LAYOUT	
I.S. INSULATION BOARD	IS 0.0.05
- GROOVE PATTERN	
COMPARTMENT SEPARATION	IS 0.0.06
FOUNDATION	IS 0.0.07
TERMINATION AT CONCRETE	IS 0.0.08
HEAD/SILL	IS 0.0.09
JAMB	IS 0.0.10
PARAPET - STEEL FRAMED, METAL COPING	IS 0.0.11
PARAPET - SOLID SUBSTRATE, METAL COPING	IS 0.0.12
SOFFIT/FASCIA INTERSECTION	IS 0.0.13
INSIDE/OUTSIDE CORNERS	IS 0.0.14
OUTSIDE CORNER - HIGH IMPACT	IS 0.0.15
HORIZONTAL EXPANSION JOINT	IS 0.0.16
HORIZONTAL SLIP JOINT	IS 0.0.17
VERTICAL EXPANSION JOINT OPTIONS	IS 0.0.18
STRUCTURAL EXPANSION JOINTS	IS 0.0.19
MINOR PENETRATIONS	IS 0.0.20
MAJOR PENETRATIONS	IS 0.0.21
SIGN ATTACHMENT	IS 0.0.22
AESTHETIC REVEALS	IS 0.0.23
PROJECTING GRAPHICS	IS 0.0.24
RECESSED GRAPHICS	IS 0.0.25
DRYVIT VENT ASSEMBLY™	IS 0.0.26

## NOTE

DRYVIT SYSTEMS, INC. MAKES NO REPRESENTATION REGARDING CONFORMITY OF ITS SUGGESTIONS TO MODEL BUILDING CODES, ENGINEERING CRITERIA, SPECIFIC APPLICATIONS OR PROJECT LOCATIONS. ALL COMPONENTS INDICATED IN ILLUSTRATIONS, AS WELL AS OTHERS THAT MAY BE REQUIRED FOR THE INTEGRITY OF THE SYSTEM SHALL BE DESIGNED, DETAILED AND ENGINEERED BY REPRESENTATIVES OF THE ARCHITECT, OWNER OR CONTRACTOR TO BE IN CONFORMANCE WITH MODEL CODES, ARCHITECTURAL AND ENGINEERING REQUIREMENTS PERTAINING TO SPECIFIC BUILDING PROJECTS.

DRYVIT SYSTEMS, INC. MAKES NO WARRANTY, EXPRESSED OR IMPLIED, AS TO THE ARCHITECTURAL DESIGN, ENGINEERING, OR WORKMANSHIP OF PROJECTS UTILIZING DRYVIT SYSTEMS OR PRODUCTS.

THE LIABILITIES OF DRYVIT SYSTEMS, INC. SHALL BE AS STATED IN THE INFINITY LIMITED COMMERCIAL WARRANTY. CONTACT DRYVIT SYSTEMS, INC. FOR A FULL AND COMPLETE COPY OF THE INFINITY WARRANTY.

## INFINITY® SYSTEM

The architecture, engineering and design of the project using the Dryvit products is the responsibility of the project's design professional. All systems must comply with local building codes and standards. This detail is for general information and guidance only and Dryvit specifically disclaims any liability for the use of this detail and for the architecture, design, engineering or workmanship of any project. The project design professional determines, in its sole discretion, whether this detail or a functionally equivalent alternative is best suited for the project. Use of a functionally equivalent detail does not violate Dryvit's warranty. This detail is subject to change without notice. Contact Dryvit to insure you have the most recent version.



## EIMA STANDARD IMPACT

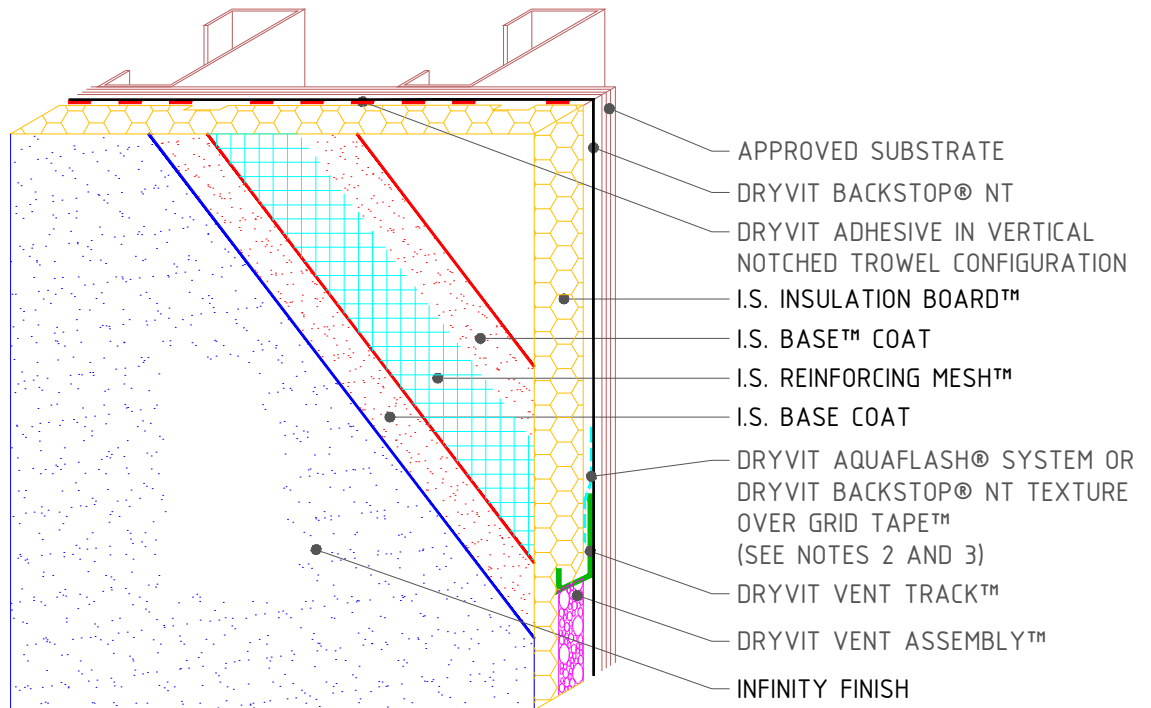

## EIMA ULTRA-HIGH IMPACT

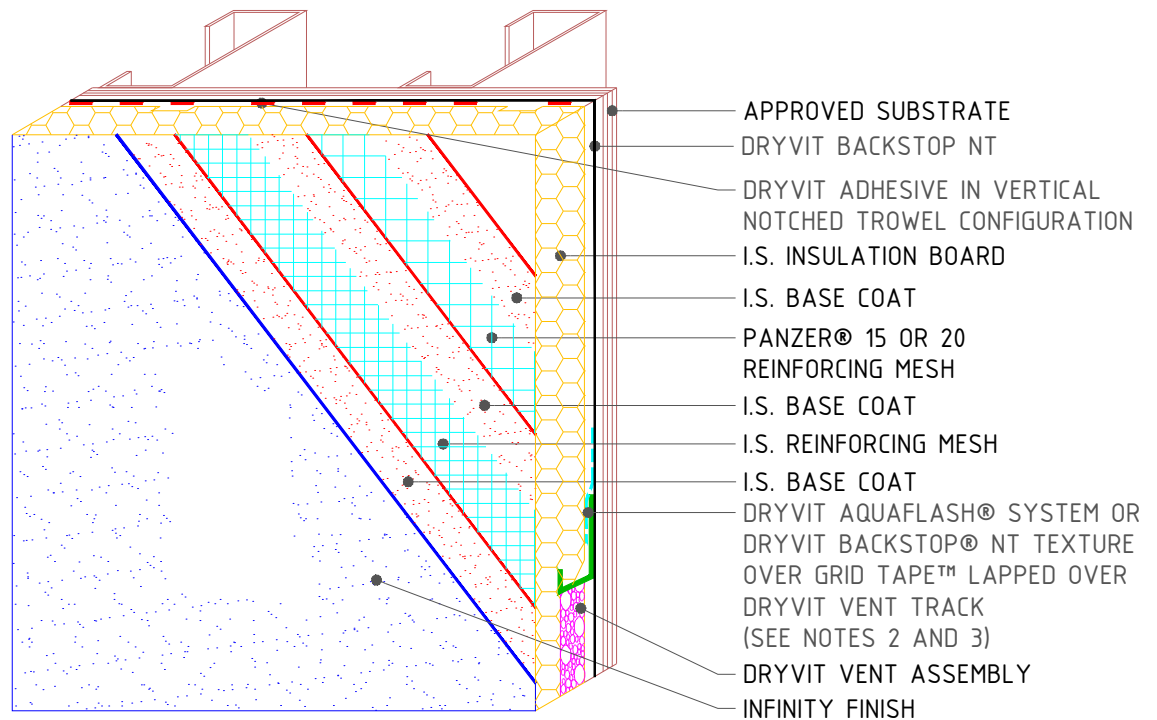

# INFINITY® SYSTEM

Infinity System

**NOTE:**

1. DRYVIT RECOMMENDS THAT GROUND FLOOR APPLICATIONS AND ALL FACADES EXPOSED TO ABNORMAL STRESS, HIGH TRAFFIC, OR DELIBERATE IMPACT HAVE THE BASE COAT REINFORCED WITH PANZER® MESH PRIOR TO I.S. REINFORCING MESH™. LOCATION OF HIGH IMPACT ZONES SHOULD BE INDICATED ON CONTRACT DRAWINGS.
2. LIGHTLY SAND SURFACE OF DRAINAGE TRACK TO MAXIMIZE ADHESION.
3. DRYVIT FLASHING TAPE SURFACE CONDITIONER™ AND DRYVIT FLASHING TAPE™ MAY BE USED LIEU OF DRYVIT AQUAFLASH SYSTEM.

The architecture, engineering and design of the project using the Dryvit products is the responsibility of the project's design professional. All systems must comply with local building codes and standards. This detail is for general information and guidance only and Dryvit specifically disclaims any liability for the use of this detail and for the architecture, design, engineering or workmanship of any project. The project design professional determines, in its sole discretion, whether this detail or a functionally equivalent alternative is best suited for the project. Use of a functionally equivalent detail does not violate Dryvit's warranty. This detail is subject to change without notice. Contact Dryvit to insure you have the most recent version.



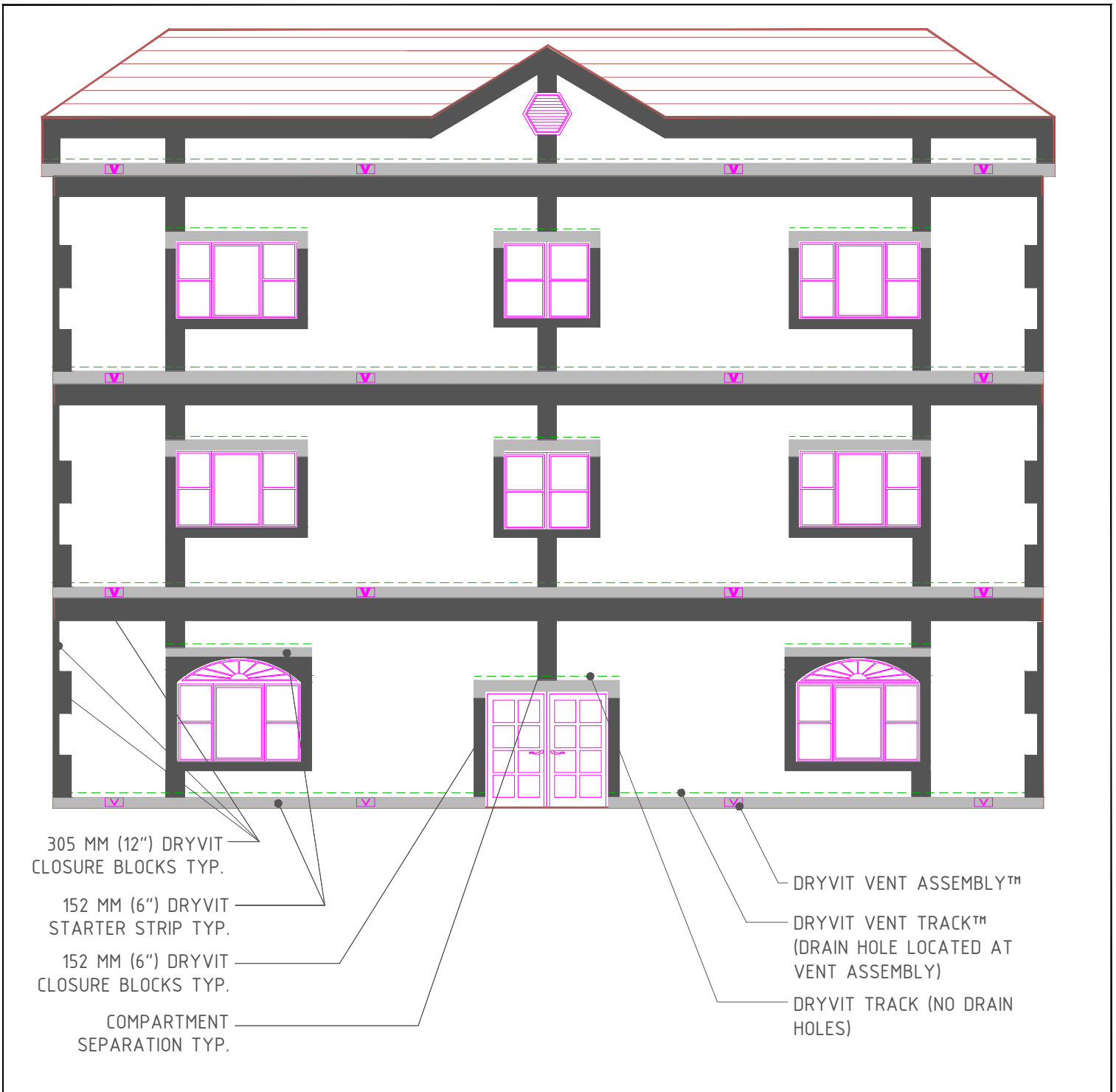

## INFINITY® SYSTEM

## Building Facade

### NOTES:

1. COMPARTMENT LOCATIONS DETERMINED PER ASCE 7-95 AND DRYVIT INFINITY SYSTEM SPECIFICATIONS DS136.

The architecture, engineering and design of the project using the Dryvit products is the responsibility of the project's design professional. All systems must comply with local building codes and standards. This detail is for general information and guidance only and Dryvit specifically disclaims any liability for the use of this detail and for the architecture, design, engineering or workmanship of any project. The project design professional determines, in its sole discretion, whether this detail or a functionally equivalent alternative is best suited for the project. Use of a functionally equivalent detail does not violate Dryvit's warranty. This detail is subject to change without notice. Contact Dryvit to insure you have the most recent version.

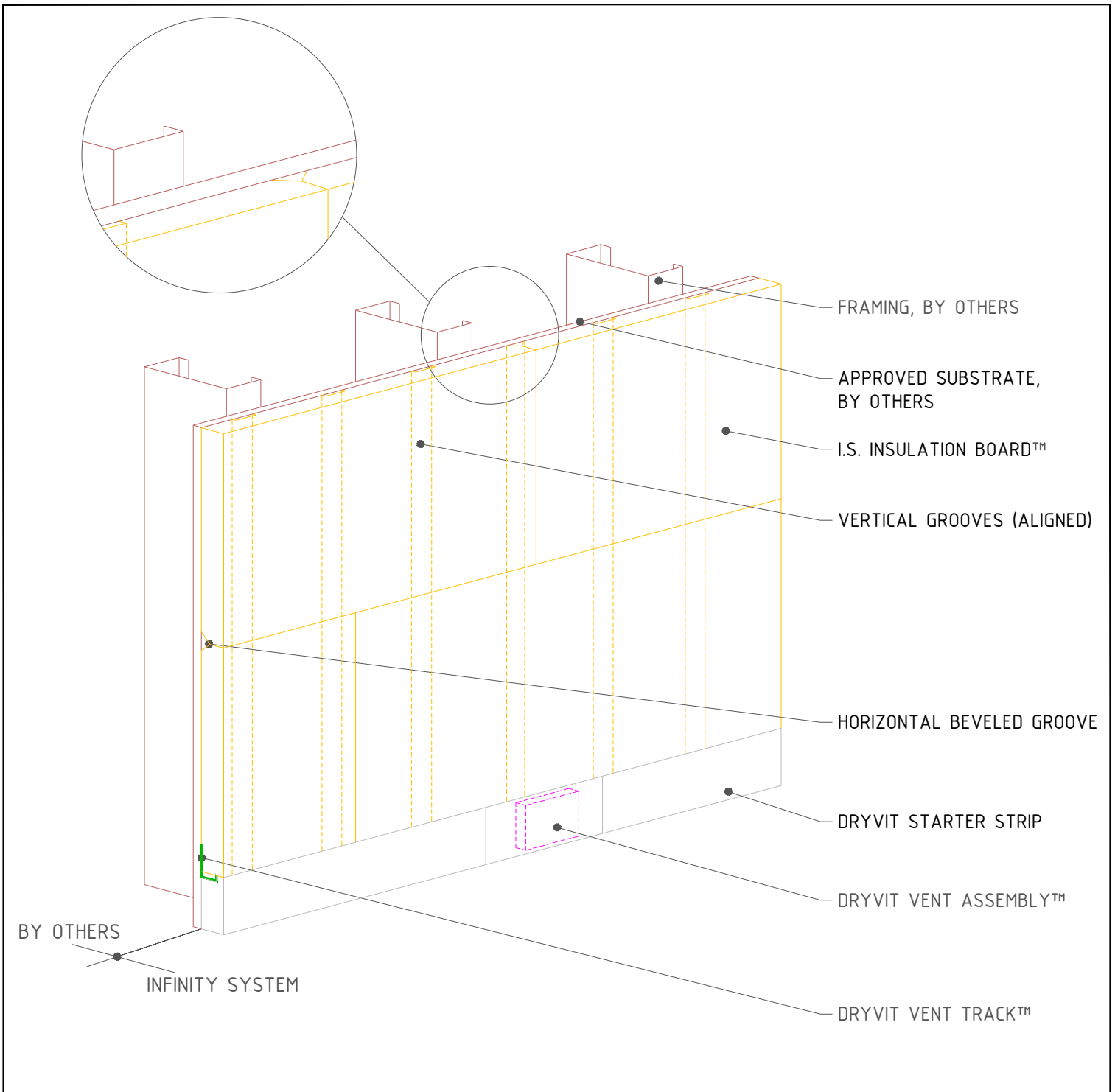

## INFINITY<sup>®</sup> SYSTEM

### I.S. Insulation Board Layout

The architecture, engineering and design of the project using the Dryvit products is the responsibility of the project's design professional. All systems must comply with local building codes and standards. This detail is for general information and guidance only and Dryvit specifically disclaims any liability for the use of this detail and for the architecture, design, engineering or workmanship of any project. The project design professional determines, in its sole discretion, whether this detail or a functionally equivalent alternative is best suited for the project. Use of a functionally equivalent detail does not violate Dryvit's warranty. This detail is subject to change without notice. Contact Dryvit to insure you have the most recent version.

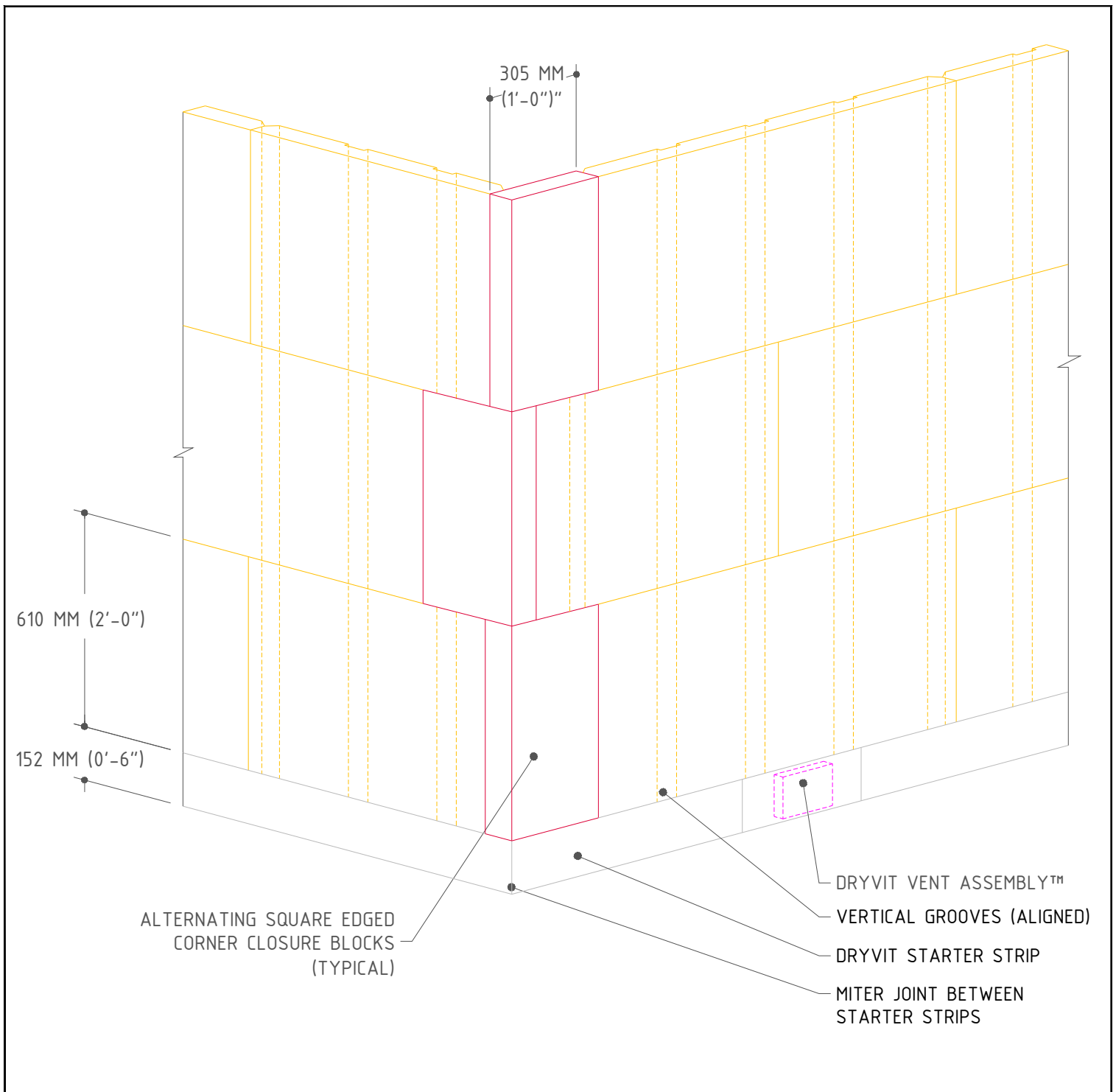

## INFINITY<sup>®</sup> SYSTEM

### Outside Corner - I.S. Insulation Board Layout

**NOTES:**

1. INSTALL SQUARE EDGED CORNER CLOSURE BLOCKS ON ALTERNATING SIDES OF OUTSIDE CORNERS.

The architecture, engineering and design of the project using the Dryvit products is the responsibility of the project's design professional. All systems must comply with local building codes and standards. This detail is for general information and guidance only and Dryvit specifically disclaims any liability for the use of this detail and for the architecture, design, engineering or workmanship of any project. The project design professional determines, in its sole discretion, whether this detail or a functionally equivalent alternative is best suited for the project. Use of a functionally equivalent detail does not violate Dryvit's warranty. This detail is subject to change without notice. Contact Dryvit to insure you have the most recent version.

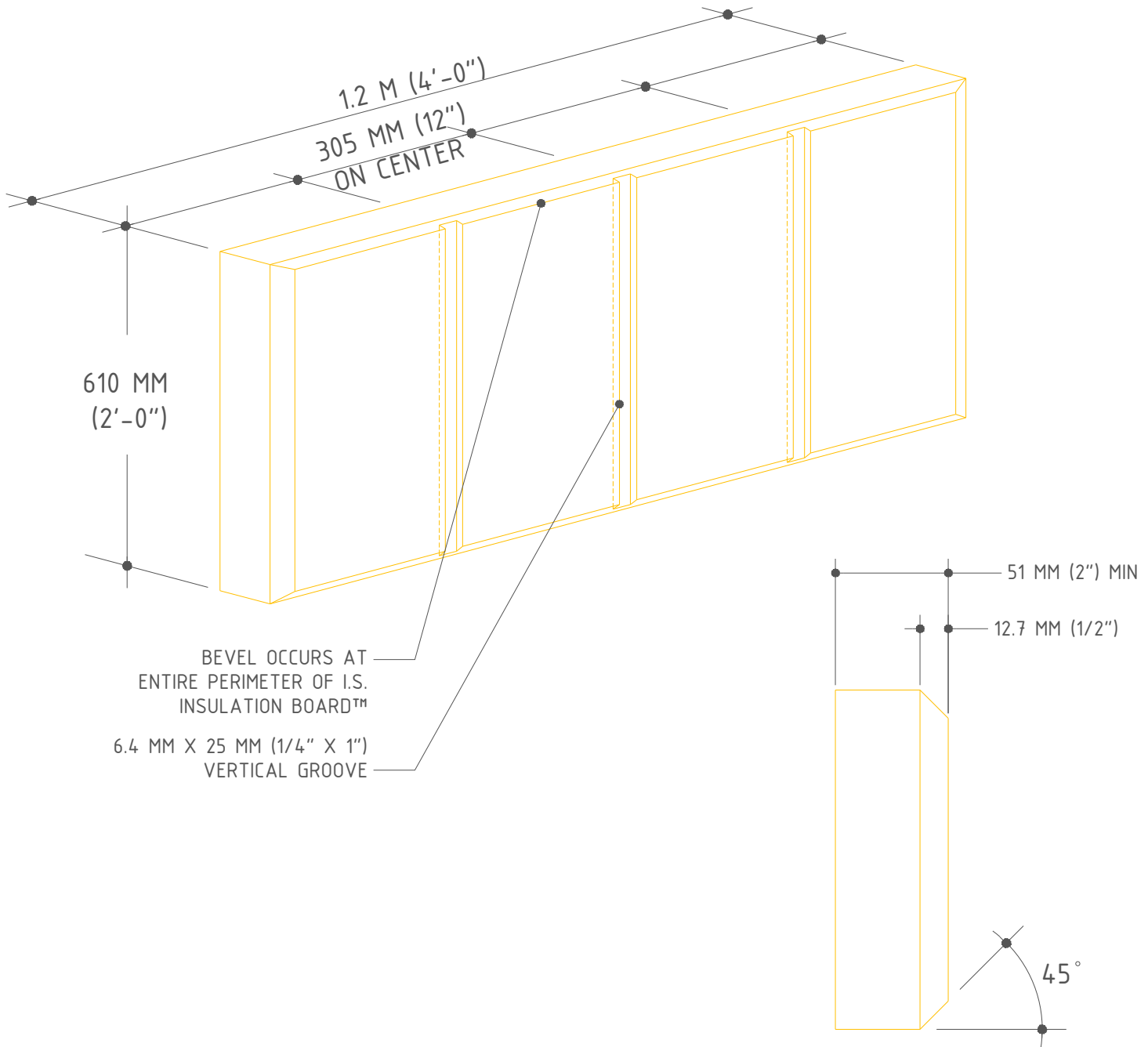

**BEVEL DETAIL**

**INFINITY® SYSTEM**

**I.S. Insulation Board- Groove Pattern**

The architecture, engineering and design of the project using the Dryvit products is the responsibility of the project's design professional. All systems must comply with local building codes and standards. This detail is for general information and guidance only and Dryvit specifically disclaims any liability for the use of this detail and for the architecture, design, engineering or workmanship of any project. The project design professional determines, in its sole discretion, whether this detail or a functionally equivalent alternative is best suited for the project. Use of a functionally equivalent detail does not violate Dryvit's warranty. This detail is subject to change without notice. Contact Dryvit to insure you have the most recent version.



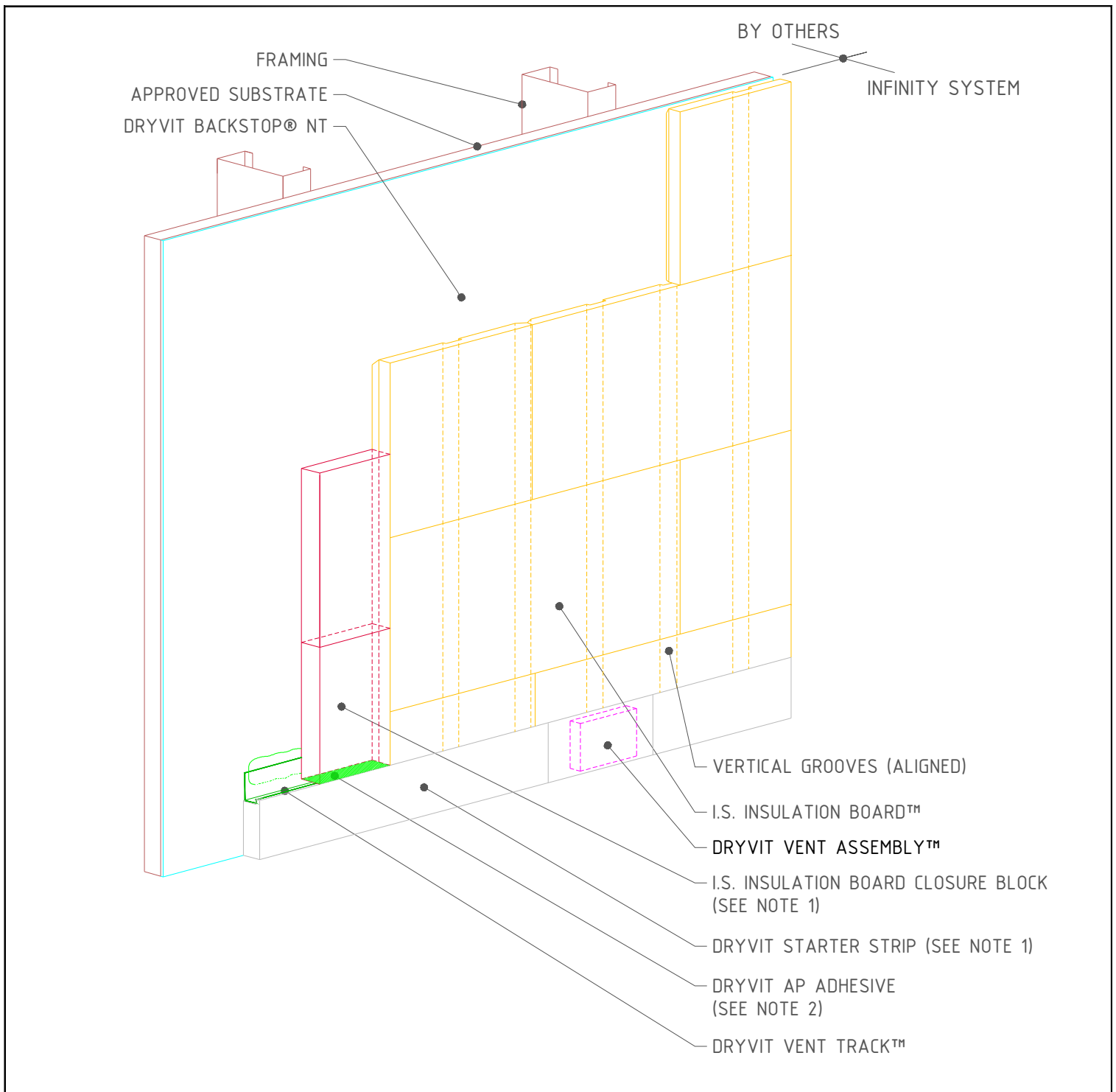

## INFINITY® SYSTEM

### Compartment Separation

#### NOTES:

1. ADHERE CLOSURE BLOCKS AND STARTER STRIPS USING "RIBBON & DAB" ADHESIVE PATTERN TO PROVIDE COMPARTMENT CLOSURE.
2. FILL DRYVIT VENT TRACK AT CLOSURE BLOCK LOCATION WITH AP ADHESIVE PRIOR TO SETTING CLOSURE BLOCK, TO PROVIDE COMPARTMENT CLOSURE.

The architecture, engineering and design of the project using the Dryvit products is the responsibility of the project's design professional. All systems must comply with local building codes and standards. This detail is for general information and guidance only and Dryvit specifically disclaims any liability for the use of this detail and for the architecture, design, engineering or workmanship of any project. The project design professional determines, in its sole discretion, whether this detail or a functionally equivalent alternative is best suited for the project. Use of a functionally equivalent detail does not violate Dryvit's warranty. This detail is subject to change without notice. Contact Dryvit to insure you have the most recent version.



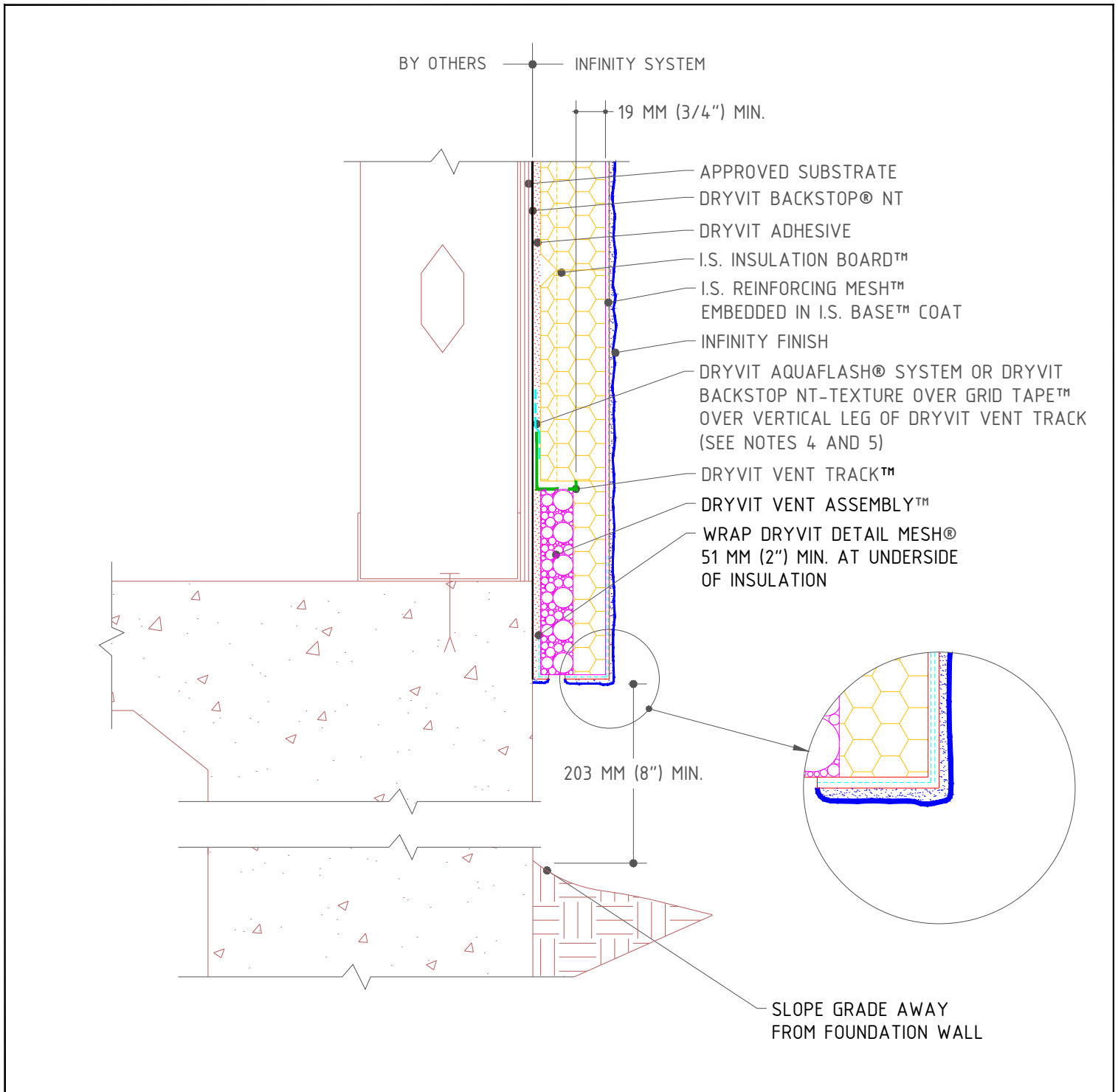

## INFINITY® SYSTEM

## Foundation

### NOTE:

1. DRYVIT RECOMMENDS THAT GROUND FLOOR APPLICATIONS AND ALL FACADES EXPOSED TO ABNORMAL STRESS, HIGH TRAFFIC, OR DELIBERATE IMPACT HAVE THE BASE COAT REINFORCED WITH PANZER® MESH PRIOR TO STANDARD™ OR STANDARD PLUS™ MESH. LOCATION OF HIGH IMPACT ZONES SHOULD BE INDICATED ON CONTRACT DRAWINGS.
2. DRYVIT VENT ASSEMBLY IS INSTALLED ONLY AT PUNCHOUT IN DRYVIT VENT TRACK.
3. EXPANSION JOINT IS REQUIRED ALONG TOP OF FOUNDATION IF 610 MM (2'-0") DIMENSION IS EXCEEDED.
4. LIGHTLY SAND SURFACE OF TRACK TO MAXIMIZE ADHESION.
5. AS AN OPTION DRYVIT FLASHING TAPE SURFACE CONDITIONER™ AND DRYVIT FLASHING TAPE™ CAN BE USED.

The architecture, engineering and design of the project using the Dryvit products is the responsibility of the project's design professional. All systems must comply with local building codes and standards. This detail is for general information and guidance only and Dryvit specifically disclaims any liability for the use of this detail and for the architecture, design, engineering or workmanship of any project. The project design professional determines, in its sole discretion, whether this detail or a functionally equivalent alternative is best suited for the project. Use of a functionally equivalent detail does not violate Dryvit's warranty. This detail is subject to change without notice. Contact Dryvit to insure you have the most recent version.

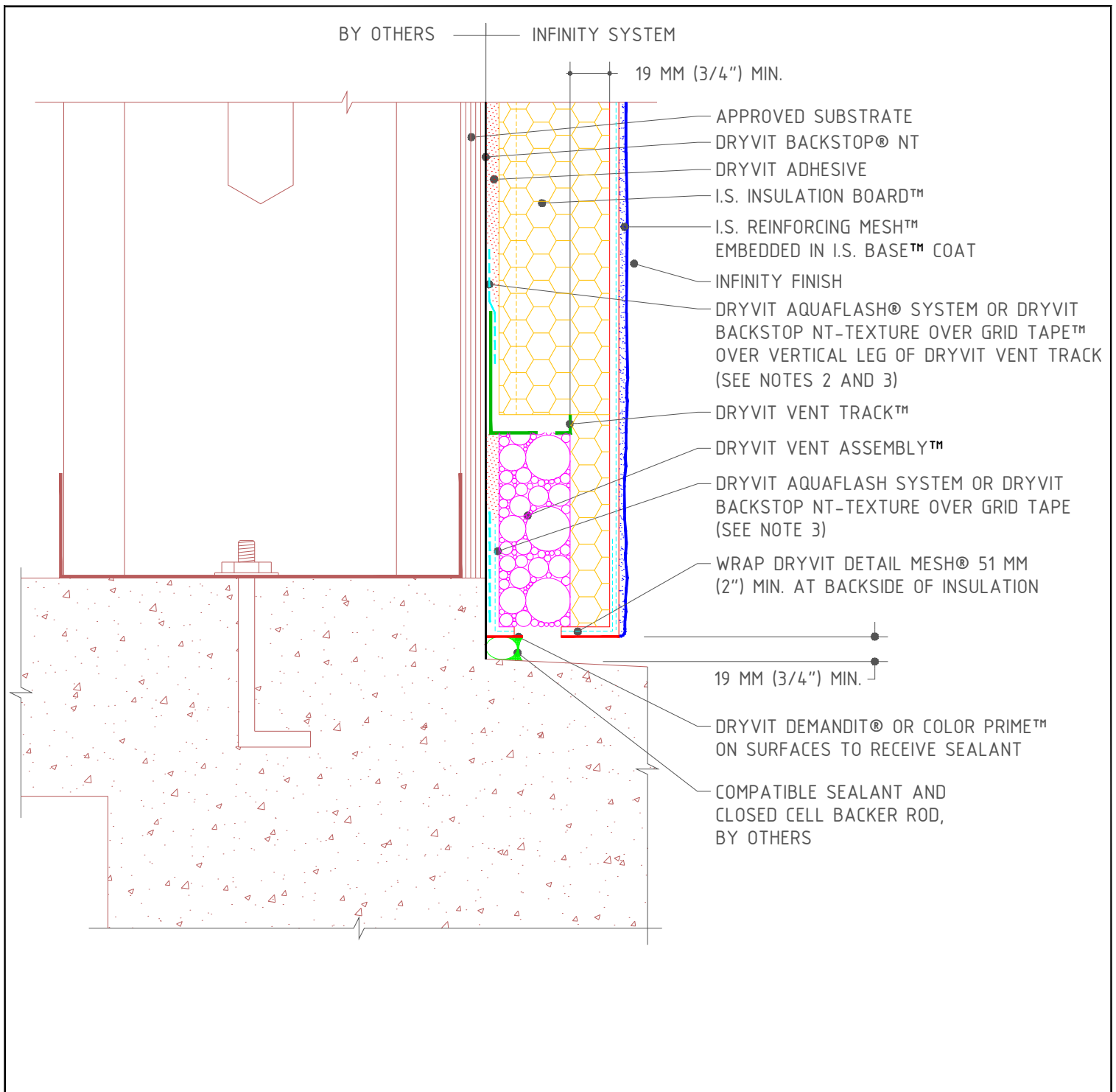

## INFINITY® SYSTEM

### Termination At Concrete

**NOTE:**

1. DRYVIT RECOMMENDS THAT GROUND FLOOR APPLICATIONS AND ALL FACADES EXPOSED TO ABNORMAL STRESS, HIGH TRAFFIC, OR DELIBERATE IMPACT HAVE THE BASE COAT REINFORCED WITH PANZER® MESH PRIOR TO STANDARD™ OR STANDARD PLUS™ MESH. LOCATION OF HIGH IMPACT ZONES SHOULD BE INDICATED ON CONTRACT DRAWINGS.
2. LIGHTLY SAND SURFACE OF TRACK TO MAXIMIZE ADHESION.
3. AS AN OPTION DRYVIT FLASHING TAPE SURFACE CONDITIONER™ AND DRYVIT FLASHING TAPE™ CAN BE USED.

The architecture, engineering and design of the project using the Dryvit products is the responsibility of the project's design professional. All systems must comply with local building codes and standards. This detail is for general information and guidance only and Dryvit specifically disclaims any liability for the use of this detail and for the architecture, design, engineering or workmanship of any project. The project design professional determines, in its sole discretion, whether this detail or a functionally equivalent alternative is best suited for the project. Use of a functionally equivalent detail does not violate Dryvit's warranty. This detail is subject to change without notice. Contact Dryvit to insure you have the most recent version.

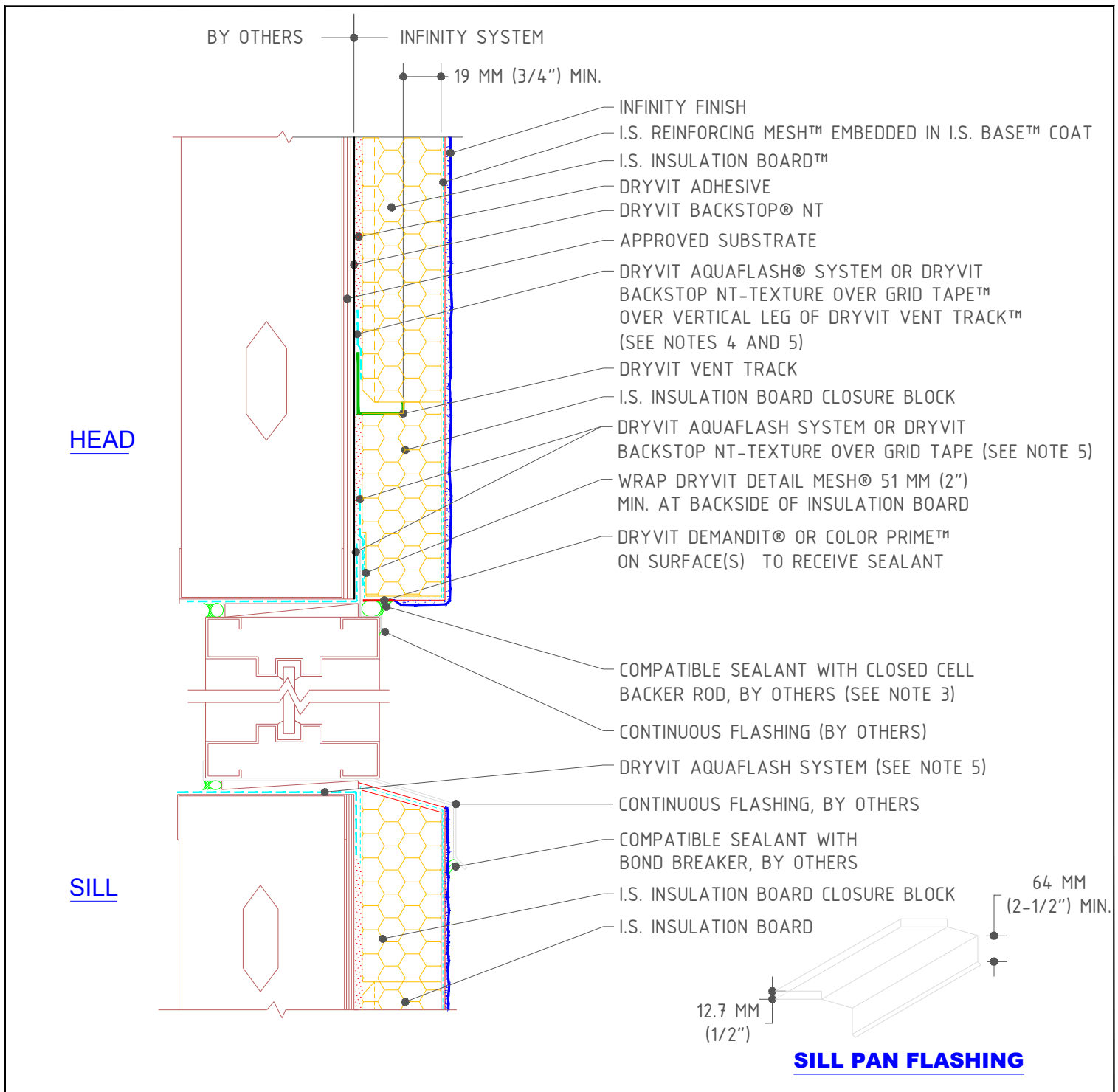

## INFINITY® SYSTEM

Head/Sill

**NOTE:**

1. DRYVIT RECOMMENDS THAT GROUND FLOOR APPLICATIONS AND ALL FACADES EXPOSED TO ABNORMAL STRESS, HIGH TRAFFIC, OR DELIBERATE IMPACT HAVE THE BASE COAT REINFORCED WITH PANZER® MESH PRIOR TO STANDARD™ OR STANDARD PLUS™ MESH. LOCATION OF HIGH IMPACT ZONES SHOULD BE INDICATED ON CONTRACT DRAWINGS.
2. FOR CONTINUOUS WINDOWS, USE CLOSURE BLOCKS TO TERMINATE SYSTEM AT SILL.

3. SEALANT SHOULD NOT BE IN DIRECT CONTACT WITH ASPHALTIC ADHESIVE ON DRYVIT FLASHING TAPE. COVER DRYVIT FLASHING TAPE LAPS WITH POLYETHYLENE TAPE OR BACKER ROD.
4. LIGHTLY SAND SURFACE OF TRACK TO MAXIMIZE ADHESION.
5. AS AN OPTION DRYVIT FLASHING TAPE SURFACE CONDITIONER™ AND DRYVIT FLASHING TAPE™ CAN BE USED.

The architecture, engineering and design of the project using the Dryvit products is the responsibility of the project's design professional. All systems must comply with local building codes and standards. This detail is for general information and guidance only and Dryvit specifically disclaims any liability for the use of this detail and for the architecture, design, engineering or workmanship of any project. The project design professional determines, in its sole discretion, whether this detail or a functionally equivalent alternative is best suited for the project. Use of a functionally equivalent detail does not violate Dryvit's warranty. This detail is subject to change without notice. Contact Dryvit to insure you have the most recent version.



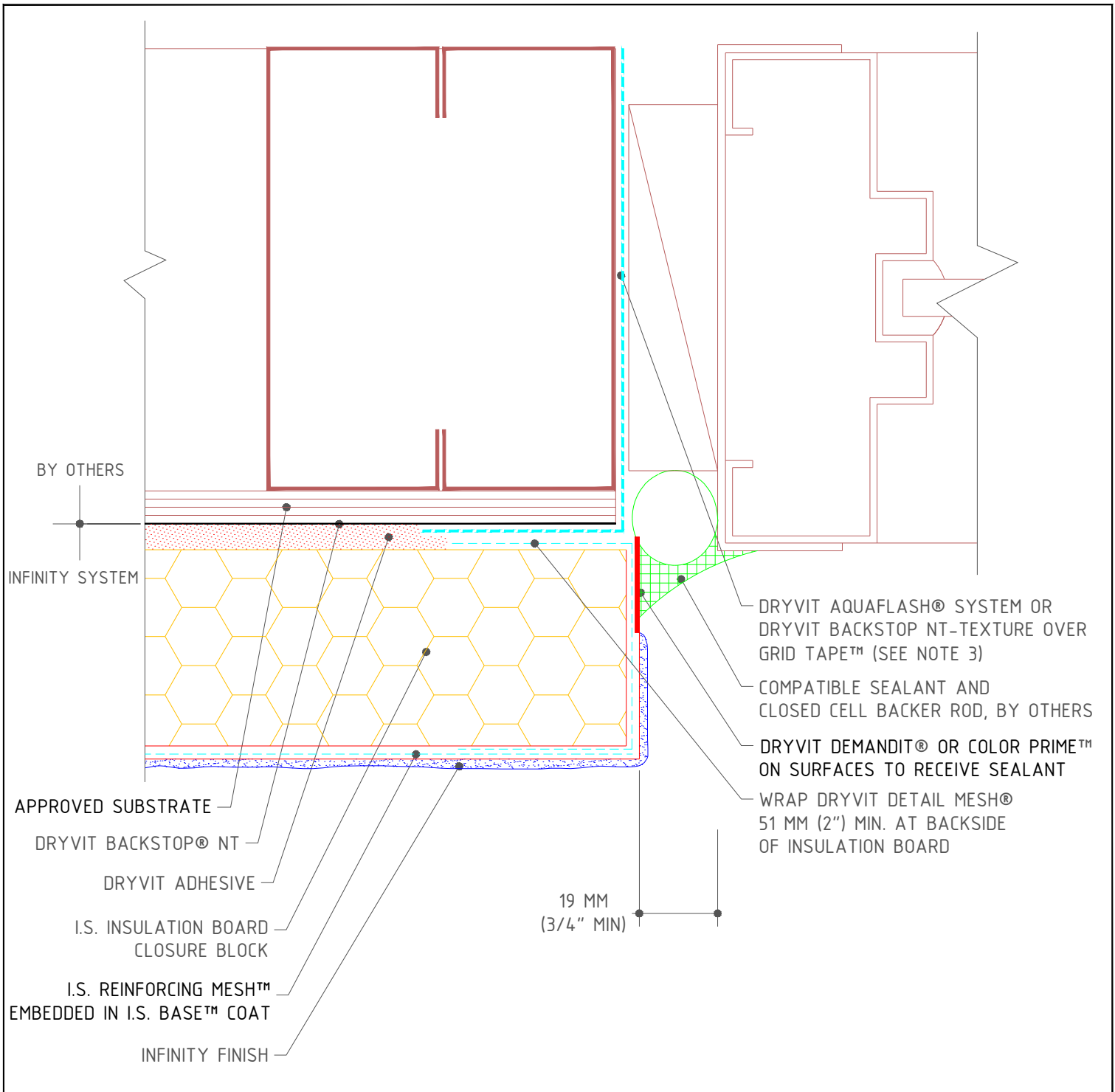

# INFINITY® SYSTEM

Jamb

**NOTE:**

1. DRYVIT RECOMMENDS THAT GROUND FLOOR APPLICATIONS AND ALL FACADES EXPOSED TO ABNORMAL STRESS, HIGH TRAFFIC, OR DELIBERATE IMPACT HAVE THE BASE COAT REINFORCED WITH PANZER® MESH PRIOR TO STANDARD™ OR STANDARD PLUS™ MESH. LOCATION OF HIGH IMPACT ZONES SHOULD BE INDICATED ON CONTRACT DRAWINGS.
2. SEALANT SHOULD NOT BE IN DIRECT CONTACT WITH ASPHALTIC ADHESIVE ON DRYVIT FLASHING TAPE. COVER DRYVIT FLASHING TAPE LAPS WITH POLYETHYLENE TAPE OR BACKER ROD.
3. AS AN OPTION DRYVIT FLASHING TAPE SURFACE CONDITIONER™ AND DRYVIT FLASHING TAPE™ CAN BE USED.

The architecture, engineering and design of the project using the Dryvit products is the responsibility of the project's design professional. All systems must comply with local building codes and standards. This detail is for general information and guidance only and Dryvit specifically disclaims any liability for the use of this detail and for the architecture, design, engineering or workmanship of any project. The project design professional determines, in its sole discretion, whether this detail or a functionally equivalent alternative is best suited for the project. Use of a functionally equivalent detail does not violate Dryvit's warranty. This detail is subject to change without notice. Contact Dryvit to insure you have the most recent version.



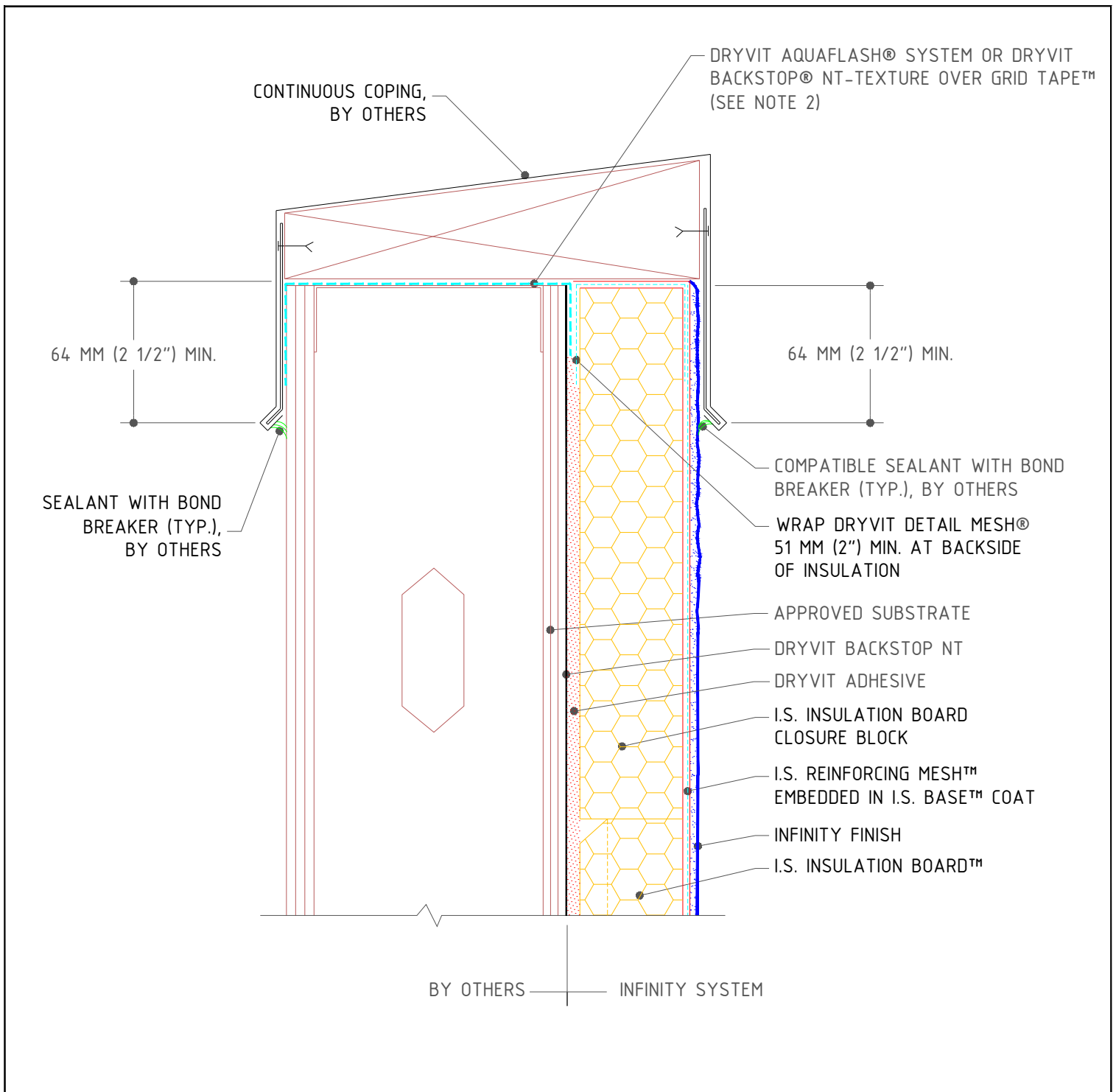

## INFINITY® SYSTEM

### Parapet - Steel Framed, Metal Coping

**NOTE:**

1. DRYVIT RECOMMENDS THAT GROUND FLOOR APPLICATIONS AND ALL FACADES EXPOSED TO ABNORMAL STRESS, HIGH TRAFFIC, OR DELIBERATE IMPACT HAVE THE BASE COAT REINFORCED WITH PANZER® 20 MESH PRIOR TO I.S. REINFORCING MESH™. LOCATION OF HIGH IMPACT ZONES SHOULD BE INDICATED ON CONTRACT DRAWINGS.
2. AS AN OPTION DRYVIT FLASHING TAPE SURFACE CONDITIONER™ AND DRYVIT FLASHING TAPE™ CAN BE USED.

The architecture, engineering and design of the project using the Dryvit products is the responsibility of the project's design professional. All systems must comply with local building codes and standards. This detail is for general information and guidance only and Dryvit specifically disclaims any liability for the use of this detail and for the architecture, design, engineering or workmanship of any project. The project design professional determines, in its sole discretion, whether this detail or a functionally equivalent alternative is best suited for the project. Use of a functionally equivalent detail does not violate Dryvit's warranty. This detail is subject to change without notice. Contact Dryvit to insure you have the most recent version.

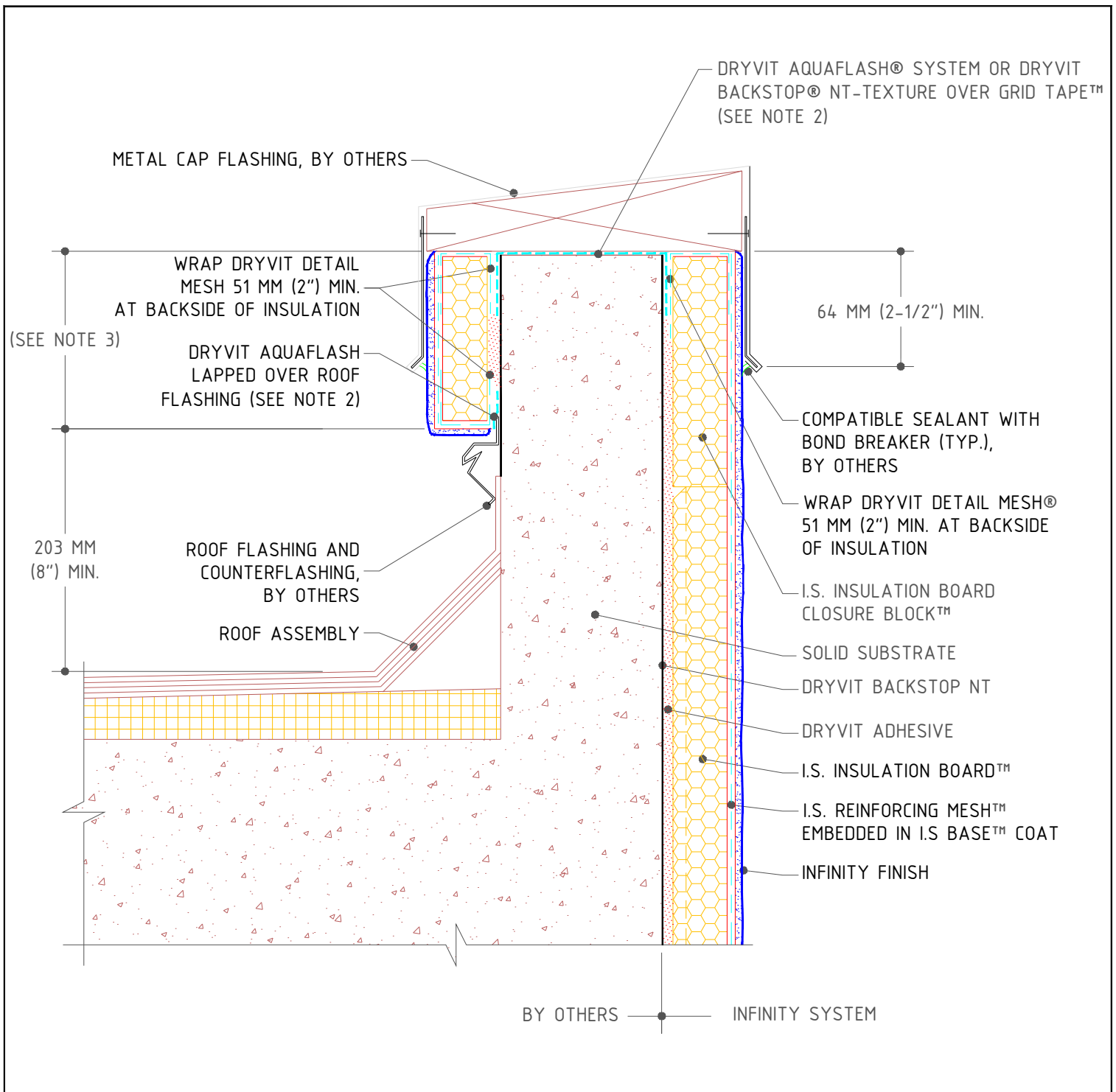

## INFINITY® SYSTEM

### Parapet - Solid Substrate, Metal Coping

**NOTE:**

1. DRYVIT RECOMMENDS THAT GROUND FLOOR APPLICATIONS AND ALL FACADES EXPOSED TO ABNORMAL STRESS, HIGH TRAFFIC, OR DELIBERATE IMPACT HAVE THE BASE COAT REINFORCED WITH PANZER® 20 MESH PRIOR TO I.S. REINFORCING MESH™. LOCATION OF HIGH IMPACT ZONES SHOULD BE INDICATED ON CONTRACT DRAWINGS.
2. AS AN OPTION DRYVIT FLASHING TAPE SURFACE CONDITIONER™ AND DRYVIT FLASHING TAPE™ CAN BE USED.
3. DIMENSIONS GREATER THAN 600 MM (2'-0") REQUIRE SYSTEM CONFIGURATION SIMILAR TO WALL FACE.

The architecture, engineering and design of the project using the Dryvit products is the responsibility of the project's design professional. All systems must comply with local building codes and standards. This detail is for general information and guidance only and Dryvit specifically disclaims any liability for the use of this detail and for the architecture, design, engineering or workmanship of any project. The project design professional determines, in its sole discretion, whether this detail or a functionally equivalent alternative is best suited for the project. Use of a functionally equivalent detail does not violate Dryvit's warranty. This detail is subject to change without notice. Contact Dryvit to insure you have the most recent version.



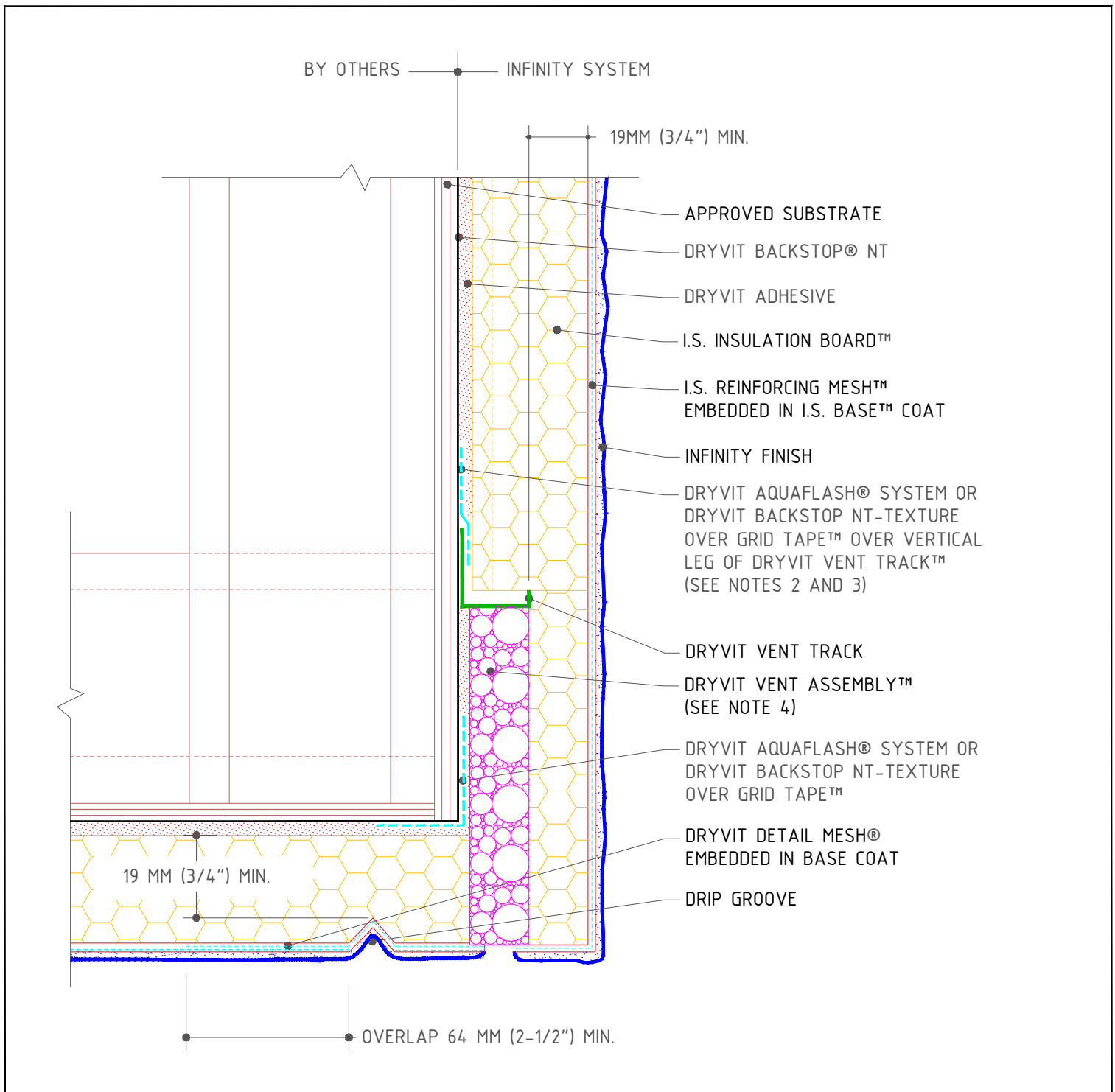

## INFINITY® SYSTEM

### Soffit/Fascia Intersection

**NOTE:**

1. DRYVIT RECOMMENDS THAT GROUND FLOOR APPLICATIONS AND ALL FACADES EXPOSED TO ABNORMAL STRESS, HIGH TRAFFIC, OR DELIBERATE IMPACT HAVE THE BASE COAT REINFORCED WITH PANZER® MESH PRIOR TO STANDARD™ OR STANDARD PLUS™ MESH. LOCATION OF HIGH IMPACT ZONES SHOULD BE INDICATED ON CONTRACT DRAWINGS.
2. LIGHTLY SAND SURFACE OF TRACK TO MAXIMIZE ADHESION.
3. AS AN OPTION DRYVIT FLASHING TAPE SURFACE CONDITIONER™ AND DRYVIT FLASHING TAPE™ CAN BE USED.
4. DRYVIT VENT ASSEMBLY IS INSTALLED ONLY AT PUNCHOUT IN DRYVIT VENT TRACK.

The architecture, engineering and design of the project using the Dryvit products is the responsibility of the project's design professional. All systems must comply with local building codes and standards. This detail is for general information and guidance only and Dryvit specifically disclaims any liability for the use of this detail and for the architecture, design, engineering or workmanship of any project. The project design professional determines, in its sole discretion, whether this detail or a functionally equivalent alternative is best suited for the project. Use of a functionally equivalent detail does not violate Dryvit's warranty. This detail is subject to change without notice. Contact Dryvit to insure you have the most recent version.



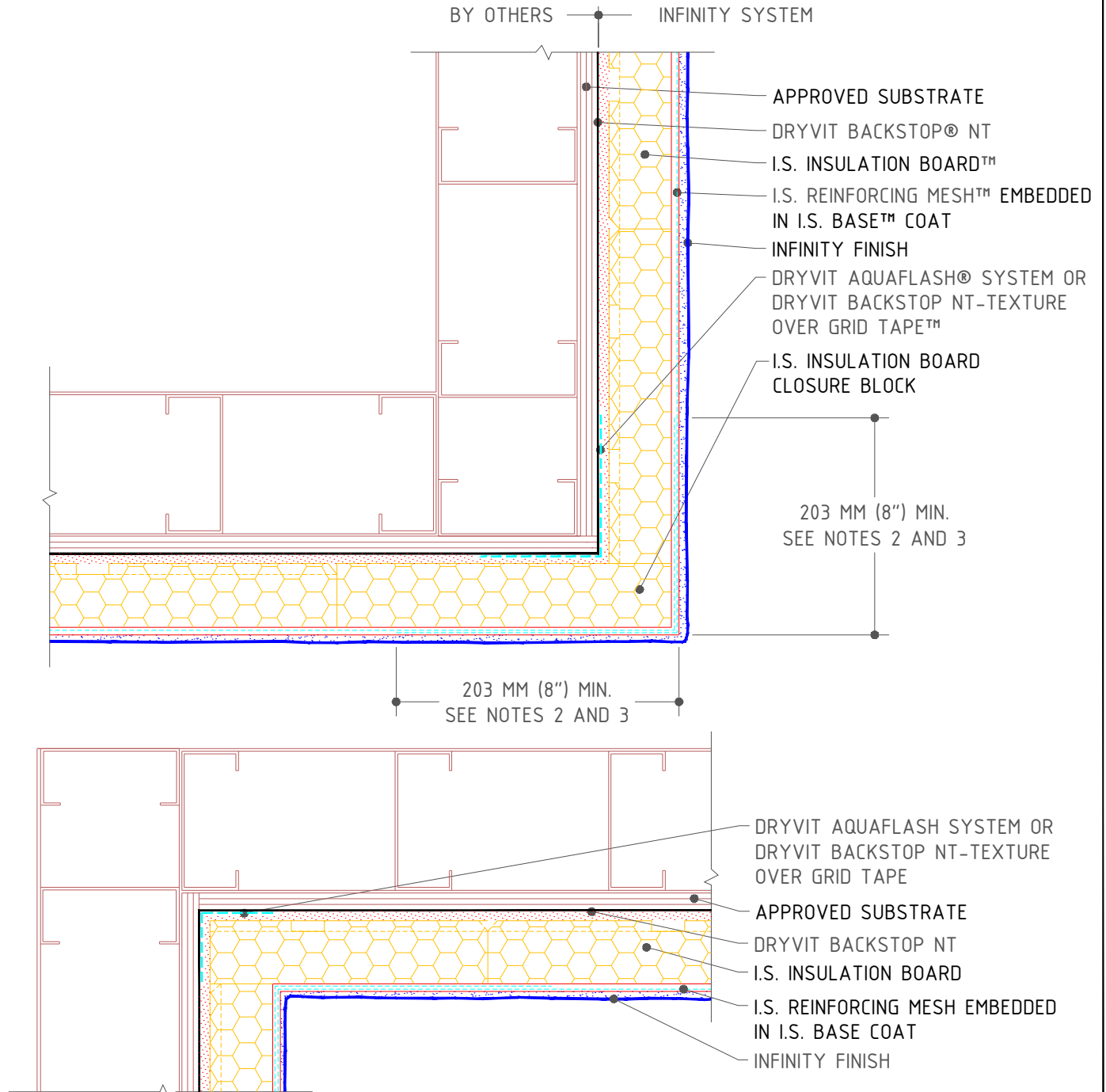

## INFINITY® SYSTEM

### Inside/Outside Corners

**NOTE:**

1. DRYVIT RECOMMENDS THAT GROUND FLOOR APPLICATIONS AND ALL FACADES EXPOSED TO ABNORMAL STRESS, HIGH TRAFFIC, OR DELIBERATE IMPACT HAVE THE BASE COAT REINFORCED WITH PANZER® MESH PRIOR TO STANDARD™ OR STANDARD PLUS™ MESH. LOCATION OF HIGH IMPACT ZONES SHOULD BE INDICATED ON CONTRACT DRAWINGS.
2. DOUBLE WRAP OUTSIDE AND INSIDE CORNERS WITH REINFORCING MESH OR USE CORNER MESH.
3. DO NOT LAP REINFORCING MESH WITHIN 203 MM (8") OF A CORNER.

The architecture, engineering and design of the project using the Dryvit products is the responsibility of the project's design professional. All systems must comply with local building codes and standards. This detail is for general information and guidance only and Dryvit specifically disclaims any liability for the use of this detail and for the architecture, design, engineering or workmanship of any project. The project design professional determines, in its sole discretion, whether this detail or a functionally equivalent alternative is best suited for the project. Use of a functionally equivalent detail does not violate Dryvit's warranty. This detail is subject to change without notice. Contact Dryvit to insure you have the most recent version.



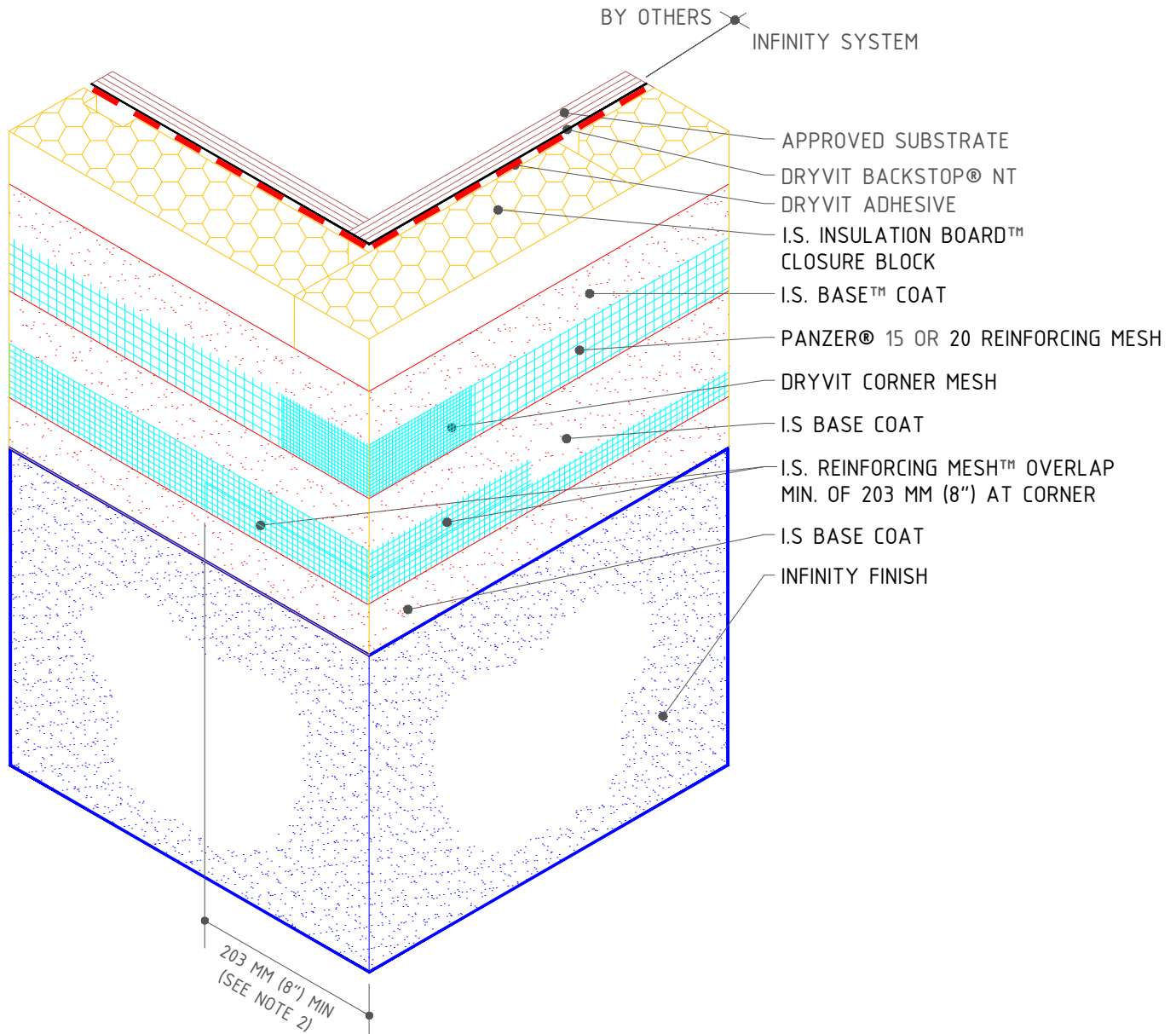

## INFINITY® SYSTEM

### Outside Corner - High Impact

**NOTE:**

1. DRYVIT RECOMMENDS THAT GROUND FLOOR APPLICATIONS AND ALL FACADES EXPOSED TO ABNORMAL STRESS, HIGH TRAFFIC, OR DELIBERATE IMPACT HAVE THE BASE COAT REINFORCED WITH PANZER® 20 MESH PRIOR TO I.S. REINFORCING MESH™. LOCATION OF HIGH IMPACT ZONES SHOULD BE INDICATED ON CONTRACT DRAWINGS.
2. DO NOT LAP REINFORCING MESH WITHIN 203 MM (8”) OF A CORNER.

The architecture, engineering and design of the project using the Dryvit products is the responsibility of the project's design professional. All systems must comply with local building codes and standards. This detail is for general information and guidance only and Dryvit specifically disclaims any liability for the use of this detail and for the architecture, design, engineering or workmanship of any project. The project design professional determines, in its sole discretion, whether this detail or a functionally equivalent alternative is best suited for the project. Use of a functionally equivalent detail does not violate Dryvit's warranty. This detail is subject to change without notice. Contact Dryvit to insure you have the most recent version.



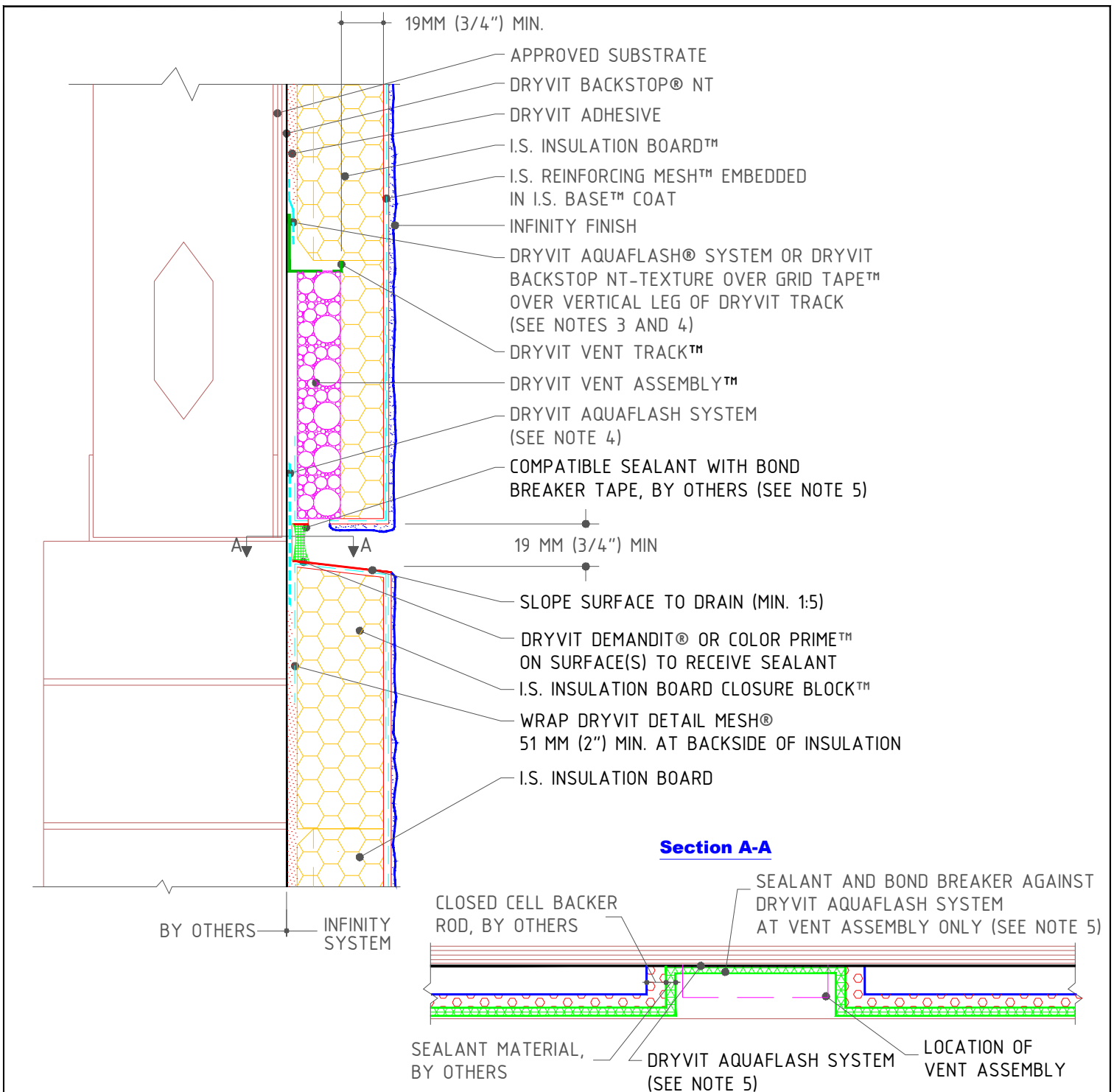

## INFINITY® SYSTEM

### Horizontal Expansion Joint

**NOTE:**

1. DRYVIT RECOMMENDS THAT GROUND FLOOR APPLICATIONS AND ALL FACADES EXPOSED TO ABNORMAL STRESS, HIGH TRAFFIC, OR DELIBERATE IMPACT HAVE THE BASE COAT REINFORCED WITH PANZER® 20 MESH PRIOR TO I.S. REINFORCING MESH™. LOCATION OF HIGH IMPACT ZONES SHOULD BE INDICATED ON CONTRACT DRAWINGS.
2. DRYVIT VENT ASSEMBLY IS INSTALLED ONLY AT PUNCHOUT IN DRYVIT VENT TRACK.
3. LIGHTLY SAND SURFACE OF TRACK TO MAXIMIZE ADHESION.
4. AS AN OPTION DRYVIT FLASHING TAPE SURFACE CONDITIONER™ AND DRYVIT FLASHING TAPE™ CAN BE USED.
5. SEALANT SHOULD NOT BE IN DIRECT CONTACT WITH ASPHALTIC ADHESIVE ON DRYVIT FLASHING TAPE. COVER DRYVIT FLASHING TAPE LAPS WITH POLYETHYLENE TAPE OR BACKER ROD.

The architecture, engineering and design of the project using the Dryvit products is the responsibility of the project's design professional. All systems must comply with local building codes and standards. This detail is for general information and guidance only and Dryvit specifically disclaims any liability for the use of this detail and for the architecture, design, engineering or workmanship of any project. The project design professional determines, in its sole discretion, whether this detail or a functionally equivalent alternative is best suited for the project. Use of a functionally equivalent detail does not violate Dryvit's warranty. This detail is subject to change without notice. Contact Dryvit to insure you have the most recent version.

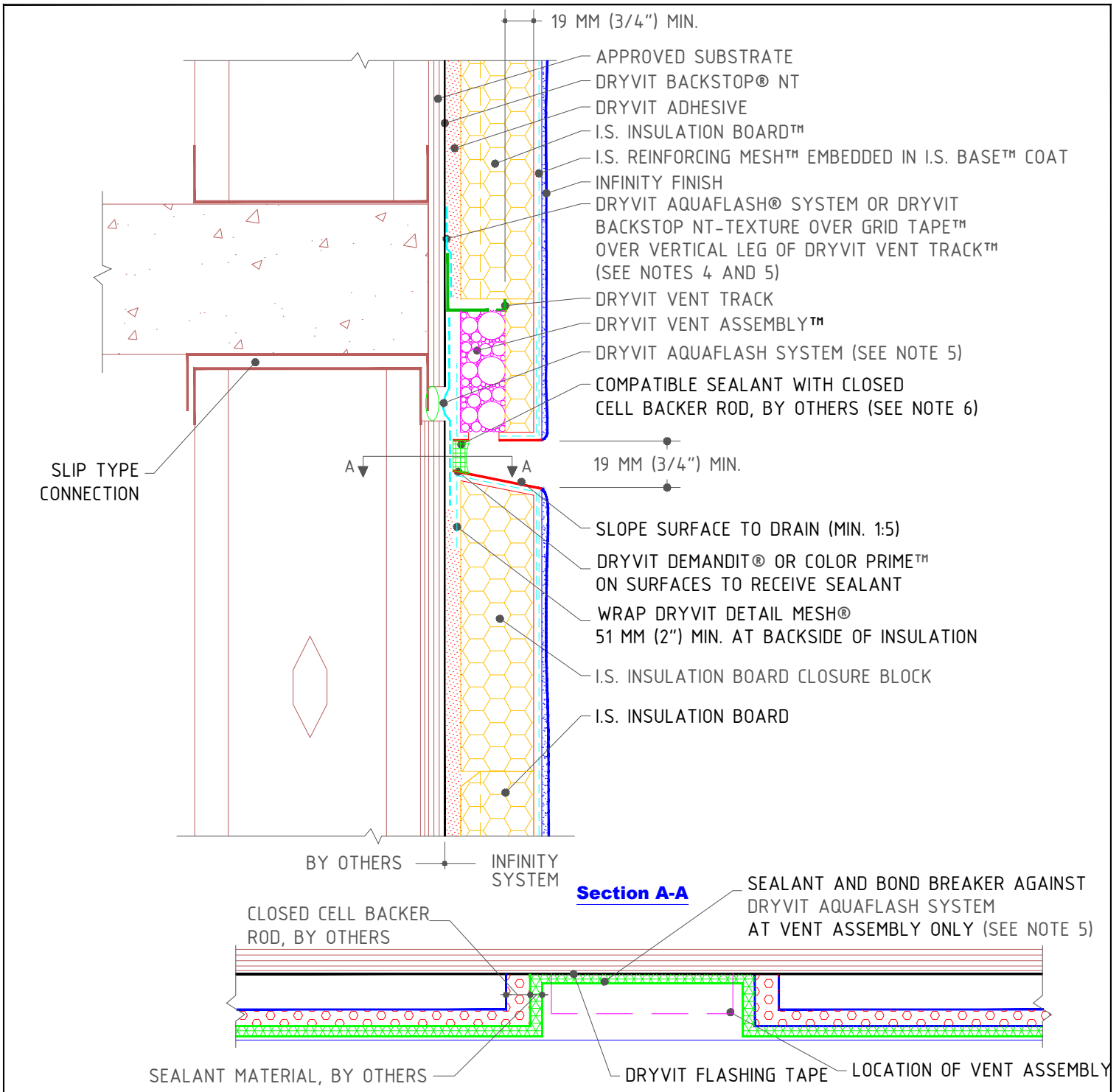

## INFINITY® SYSTEM

### Horizontal Slip Joint

#### NOTE:

1. DRYVIT RECOMMENDS THAT GROUND FLOOR APPLICATIONS AND ALL FACADES EXPOSED TO ABNORMAL STRESS, HIGH TRAFFIC, OR DELIBERATE IMPACT HAVE THE BASE COAT REINFORCED WITH PANZER® 20 MESH PRIOR TO I.S. REINFORCING MESH™. LOCATION OF HIGH IMPACT ZONES SHOULD BE INDICATED ON CONTRACT DRAWINGS.
2. EXPANSION JOINT IN THE INFINITY SYSTEM IS NECESSARY WHERE

SIGNIFICANT DIFFERENTIAL MOVEMENT IS EXPECTED AT FLOOR LINES.

3. LOCATE EXTERNAL SEALANT JOINT A MAXIMUM OF 51 MM (2") BELOW BREAK IN SUBSTRATE.
5. LIGHTLY SAND SURFACE OF TRACK TO MAXIMIZE ADHESION.
6. AS AN OPTION DRYVIT FLASHING TAPE SURFACE CONDITIONER™ AND DRYVIT FLASHING TAPE™ CAN BE USED.
4. SEALANT SHOULD NOT BE IN DIRECT CONTACT WITH ASPHALTIC ADHESIVE ON DRYVIT FLASHING TAPE. COVER FLASHING TAPE LAPS WITH POLYETHYLENE TAPE OR BACKER ROD.

The architecture, engineering and design of the project using the Dryvit products is the responsibility of the project's design professional. All systems must comply with local building codes and standards. This detail is for general information and guidance only and Dryvit specifically disclaims any liability for the use of this detail and for the architecture, design, engineering or workmanship of any project. The project design professional determines, in its sole discretion, whether this detail or a functionally equivalent alternative is best suited for the project. Use of a functionally equivalent detail does not violate Dryvit's warranty. This detail is subject to change without notice. Contact Dryvit to insure you have the most recent version.

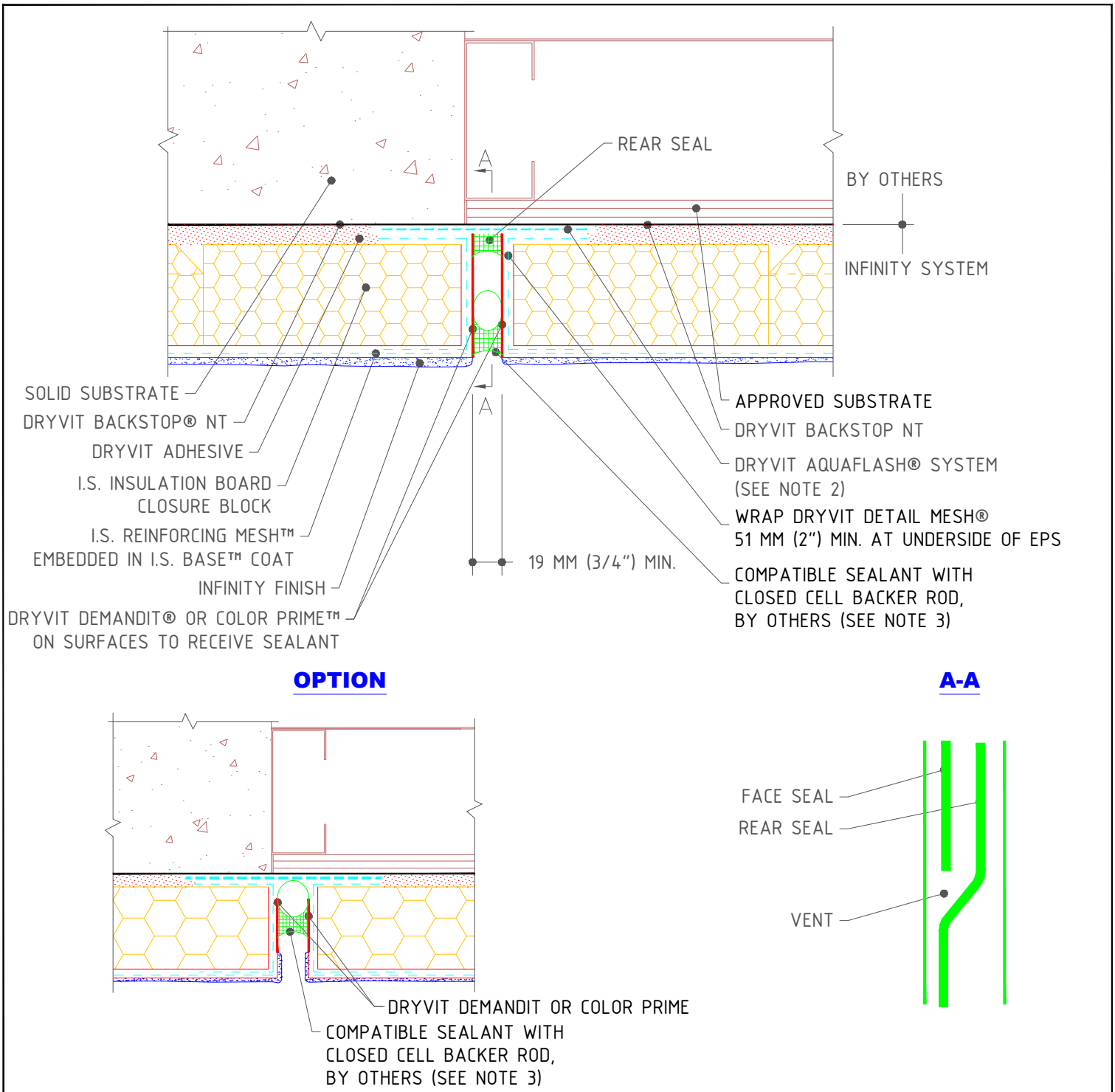

## INFINITY® SYSTEM

### Vertical Expansion Joint Options

**NOTE:**

1. DRYVIT RECOMMENDS THAT GROUND FLOOR APPLICATIONS AND ALL FACADES EXPOSED TO ABNORMAL STRESS, HIGH TRAFFIC, OR DELIBERATE IMPACT HAVE THE BASE COAT REINFORCED WITH PANZER® MESH PRIOR TO STANDARD™ OR STANDARD PLUS™ MESH. LOCATION OF HIGH IMPACT ZONES SHOULD BE INDICATED ON CONTRACT DRAWINGS.
2. AS AN OPTION DRYVIT FLASHING TAPE SURFACE CONDITIONER™ AND DRYVIT FLASHING TAPE™ CAN BE USED.
3. SEALANT SHOULD NOT BE IN DIRECT CONTACT WITH ASPHALTIC ADHESIVE ON DRYVIT FLASHING TAPE. COVER DRYVIT FLASHING TAPE LAPS WITH POLYETHYLENE TAPE OR BACKER ROD.

The architecture, engineering and design of the project using the Dryvit products is the responsibility of the project's design professional. All systems must comply with local building codes and standards. This detail is for general information and guidance only and Dryvit specifically disclaims any liability for the use of this detail and for the architecture, design, engineering or workmanship of any project. The project design professional determines, in its sole discretion, whether this detail or a functionally equivalent alternative is best suited for the project. Use of a functionally equivalent detail does not violate Dryvit's warranty. This detail is subject to change without notice. Contact Dryvit to insure you have the most recent version.



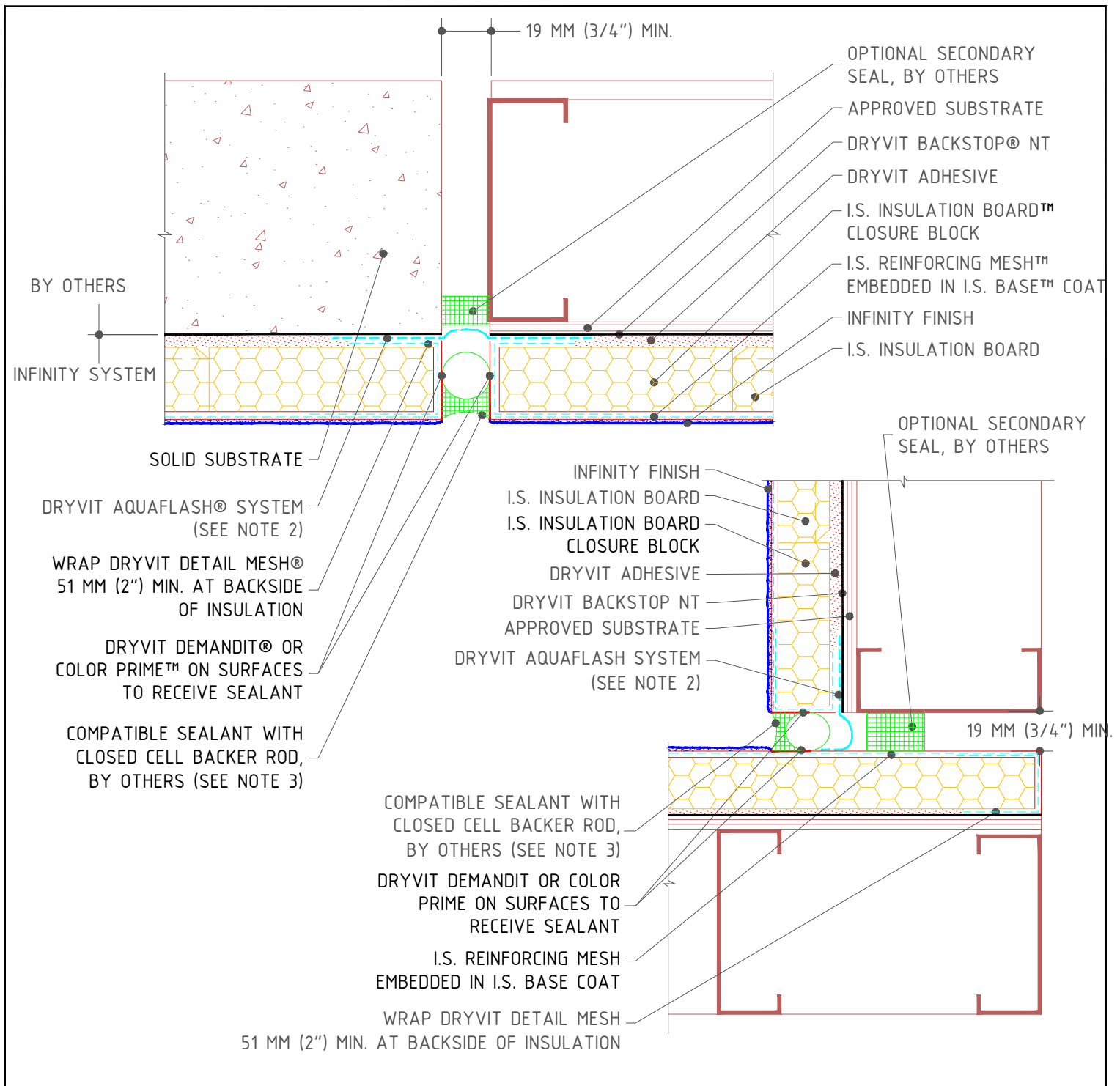

## INFINITY® SYSTEM

## Structural Expansion Joints

### NOTE:

1. DRYVIT RECOMMENDS THAT GROUND FLOOR APPLICATIONS AND ALL FACADES EXPOSED TO ABNORMAL STRESS, HIGH TRAFFIC, OR DELIBERATE IMPACT HAVE THE BASE COAT REINFORCED WITH PANZER® MESH PRIOR TO STANDARD™ OR STANDARD PLUS™ MESH. LOCATION OF HIGH IMPACT ZONES SHOULD BE INDICATED ON CONTRACT DRAWINGS.

2. AS AN OPTION DRYVIT FLASHING TAPE SURFACE CONDITIONER™ AND DRYVIT FLASHING TAPE™ CAN BE USED.

3. SEALANT SHOULD NOT BE IN DIRECT CONTACT WITH ASPHALTIC ADHESIVE ON DRYVIT FLASHING TAPE. COVER DRYVIT FLASHING TAPE LAPS WITH POLYETHYLENE TAPE OR BACKER ROD.

The architecture, engineering and design of the project using the Dryvit products is the responsibility of the project's design professional. All systems must comply with local building codes and standards. This detail is for general information and guidance only and Dryvit specifically disclaims any liability for the use of this detail and for the architecture, design, engineering or workmanship of any project. The project design professional determines, in its sole discretion, whether this detail or a functionally equivalent alternative is best suited for the project. Use of a functionally equivalent detail does not violate Dryvit's warranty. This detail is subject to change without notice. Contact Dryvit to insure you have the most recent version.

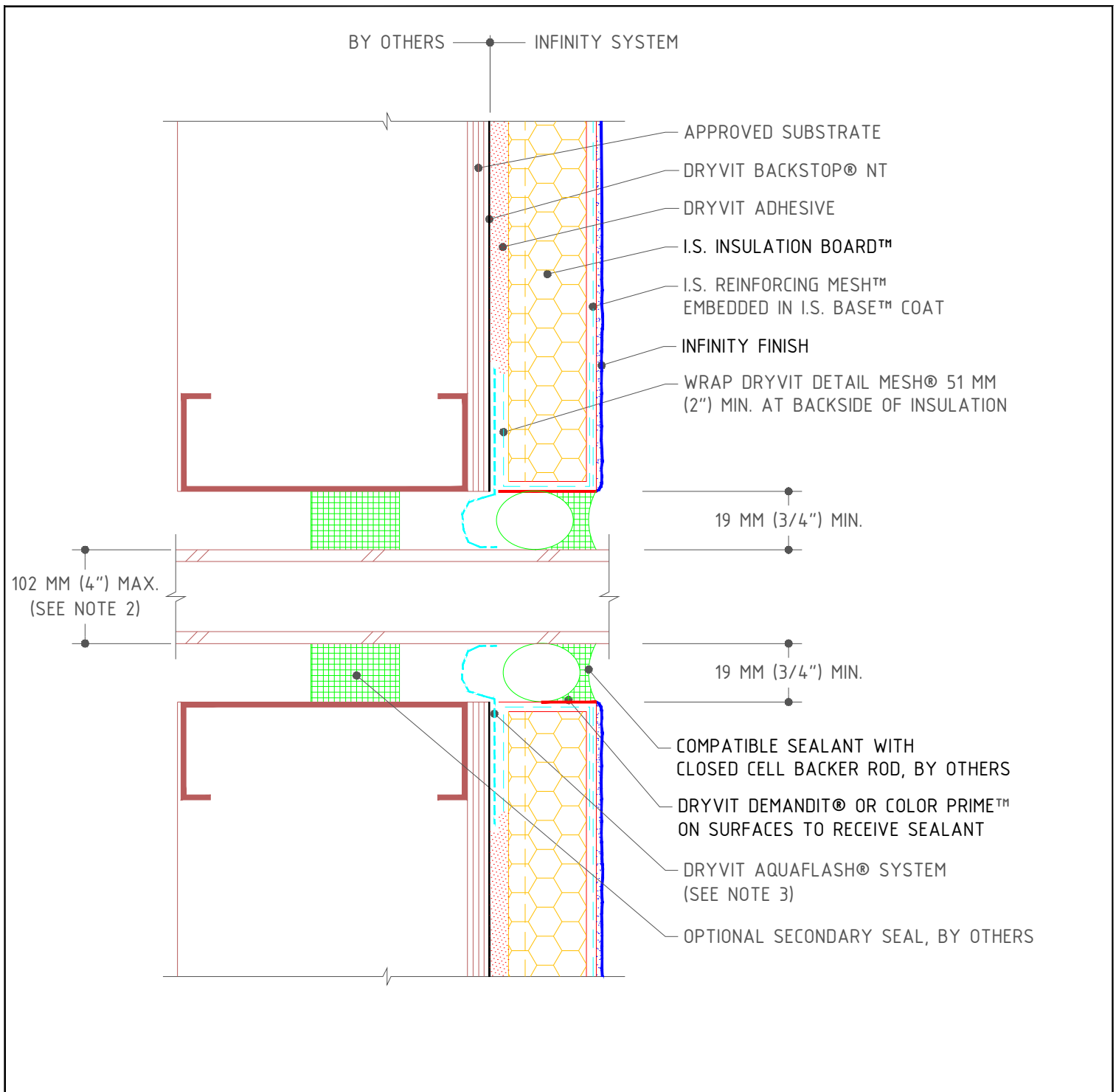

## INFINITY® SYSTEM

### Minor Penetrations

#### NOTE:

1. DRYVIT RECOMMENDS THAT GROUND FLOOR APPLICATIONS AND ALL FACADES EXPOSED TO ABNORMAL STRESS, HIGH TRAFFIC, OR DELIBERATE IMPACT HAVE THE BASE COAT REINFORCED WITH PANZER® MESH PRIOR TO STANDARD™ OR STANDARD PLUS™ MESH. LOCATION OF HIGH IMPACT ZONES SHOULD BE INDICATED ON CONTRACT DRAWINGS.
2. FOR LARGER PENETRATIONS REFER TO DETAIL IS 0.0.21
3. AS AN OPTION DRYVIT FLASHING TAPE SURFACE CONDITIONER™ AND DRYVIT FLASHING TAPE™ CAN BE USED.

The architecture, engineering and design of the project using the Dryvit products is the responsibility of the project's design professional. All systems must comply with local building codes and standards. This detail is for general information and guidance only and Dryvit specifically disclaims any liability for the use of this detail and for the architecture, design, engineering or workmanship of any project. The project design professional determines, in its sole discretion, whether this detail or a functionally equivalent alternative is best suited for the project. Use of a functionally equivalent detail does not violate Dryvit's warranty. This detail is subject to change without notice. Contact Dryvit to insure you have the most recent version.

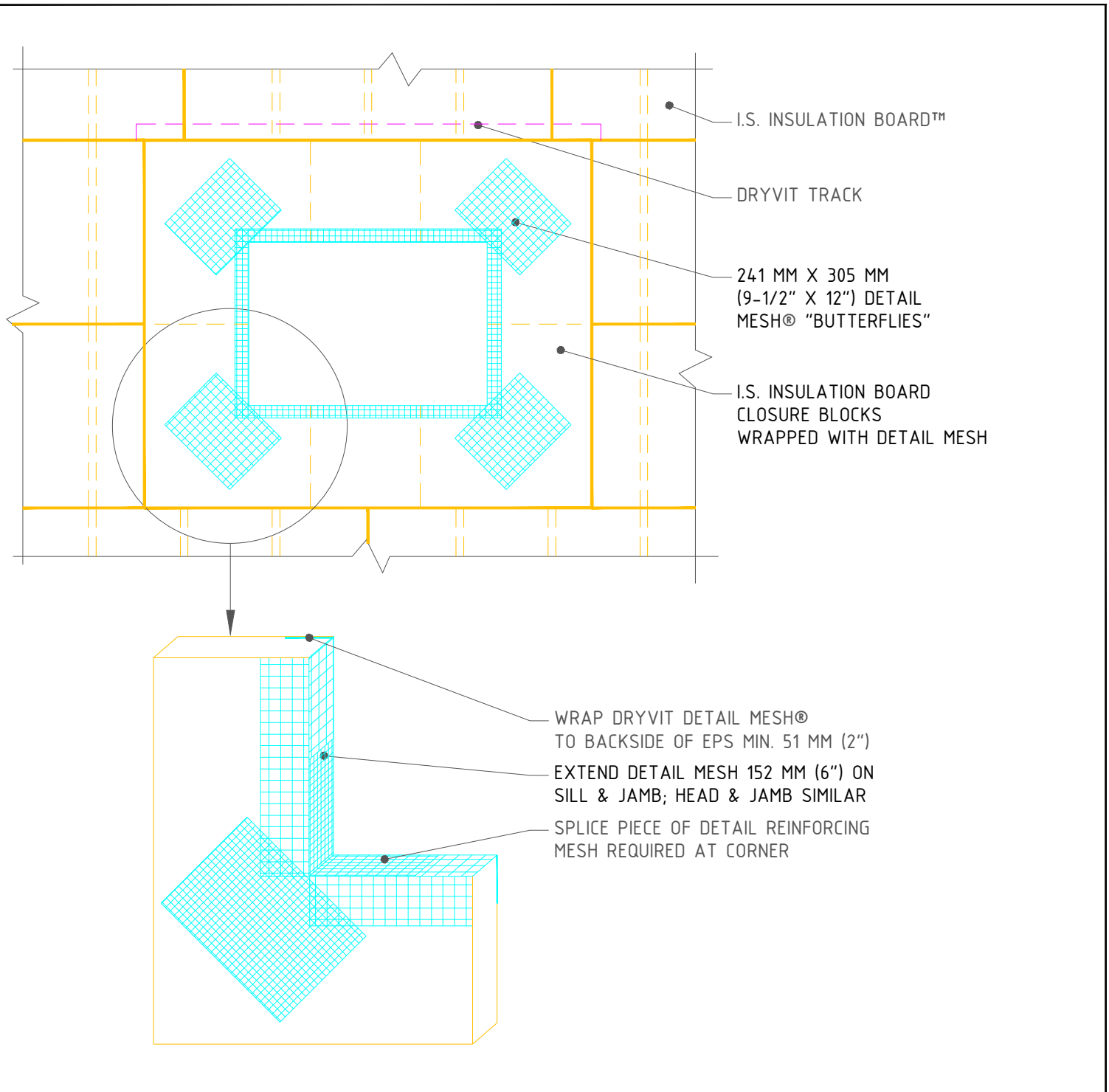

## INFINITY® SYSTEM

### Major Penetrations

**NOTE:**

1. DRYVIT RECOMMENDS THAT GROUND FLOOR APPLICATIONS AND ALL FACADES EXPOSED TO ABNORMAL STRESS, HIGH TRAFFIC, OR DELIBERATE IMPACT HAVE THE BASE COAT REINFORCED WITH PANZER® MESH PRIOR TO STANDARD™ OR STANDARD PLUS™ MESH. LOCATION OF HIGH IMPACT ZONES SHOULD BE INDICATED ON CONTRACT DRAWINGS.
2. LOCATE INSULATION BOARDS SUCH THAT BOARD EDGES DO NOT ALIGN WITH CORNERS OF PENETRATION.
3. TO MINIMIZE CRACKING AT CORNERS OF PENETRATIONS INSTALL DIAGONAL REINFORCING MESH.

The architecture, engineering and design of the project using the Dryvit products is the responsibility of the project's design professional. All systems must comply with local building codes and standards. This detail is for general information and guidance only and Dryvit specifically disclaims any liability for the use of this detail and for the architecture, design, engineering or workmanship of any project. The project design professional determines, in its sole discretion, whether this detail or a functionally equivalent alternative is best suited for the project. Use of a functionally equivalent detail does not violate Dryvit's warranty. This detail is subject to change without notice. Contact Dryvit to insure you have the most recent version.

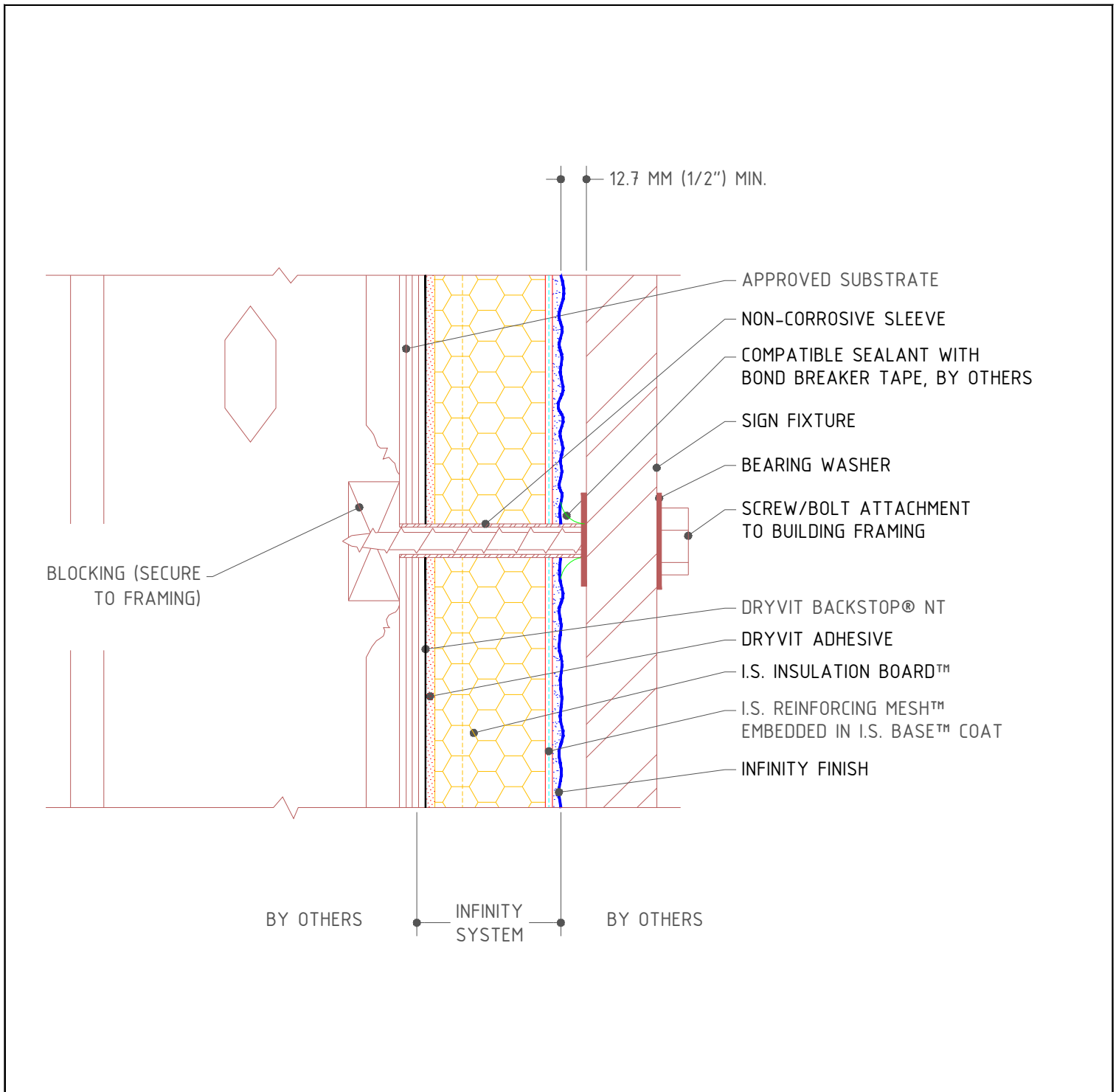

## INFINITY<sup>®</sup> SYSTEM

## Sign Attachment

### NOTE:

1. DRYVIT RECOMMENDS THAT GROUND FLOOR APPLICATIONS AND ALL FACADES EXPOSED TO ABNORMAL STRESS, HIGH TRAFFIC, OR DELIBERATE IMPACT HAVE THE BASE COAT REINFORCED WITH PANZER<sup>®</sup> MESH PRIOR TO STANDARD<sup>™</sup> OR STANDARD PLUS<sup>™</sup> MESH. LOCATION OF HIGH IMPACT ZONES SHOULD BE INDICATED ON CONTRACT DRAWINGS.

2. ENTIRE PERIMETER OF PIPE SLEEVE IS CAULKED TO PREVENT WATER ENTRY INTO WALL.

The architecture, engineering and design of the project using the Dryvit products is the responsibility of the project's design professional. All systems must comply with local building codes and standards. This detail is for general information and guidance only and Dryvit specifically disclaims any liability for the use of this detail and for the architecture, design, engineering or workmanship of any project. The project design professional determines, in its sole discretion, whether this detail or a functionally equivalent alternative is best suited for the project. Use of a functionally equivalent detail does not violate Dryvit's warranty. This detail is subject to change without notice. Contact Dryvit to insure you have the most recent version.



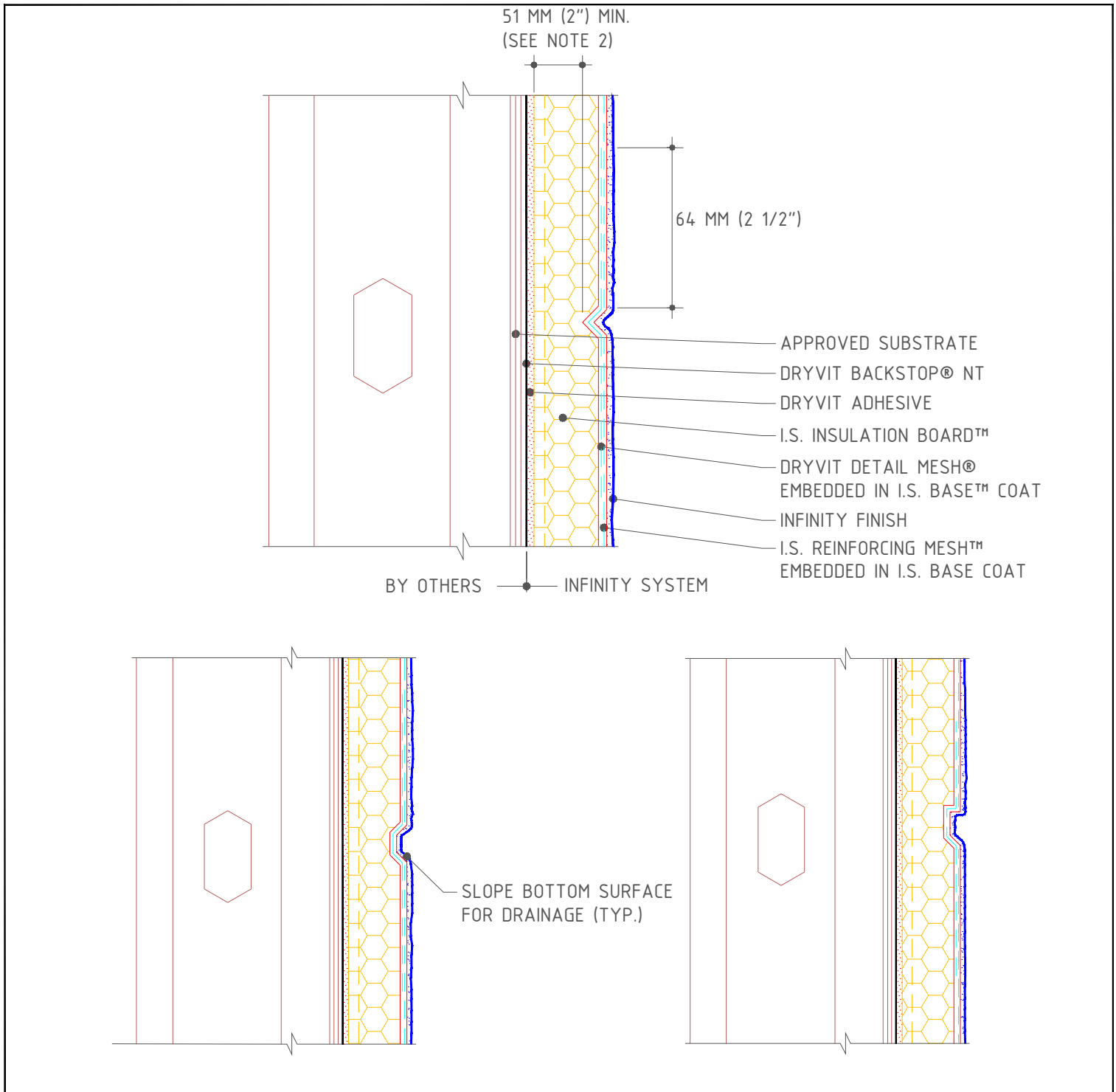

## INFINITY® SYSTEM

### Aesthetic Reveals

**NOTE:**

1. DRYVIT RECOMMENDS THAT GROUND FLOOR APPLICATIONS AND ALL FACADES EXPOSED TO ABNORMAL STRESS, HIGH TRAFFIC, OR DELIBERATE IMPACT HAVE THE BASE COAT REINFORCED WITH PANZER® MESH PRIOR TO STANDARD™ OR STANDARD PLUS™ MESH. LOCATION OF HIGH IMPACT ZONES SHOULD BE INDICATED ON CONTRACT DRAWINGS.
2. MIN. 51 MM (2") THICKNESS OF EPS IS REQUIRED AT BASE OF REVEALS.

The architecture, engineering and design of the project using the Dryvit products is the responsibility of the project's design professional. All systems must comply with local building codes and standards. This detail is for general information and guidance only and Dryvit specifically disclaims any liability for the use of this detail and for the architecture, design, engineering or workmanship of any project. The project design professional determines, in its sole discretion, whether this detail or a functionally equivalent alternative is best suited for the project. Use of a functionally equivalent detail does not violate Dryvit's warranty. This detail is subject to change without notice. Contact Dryvit to insure you have the most recent version.



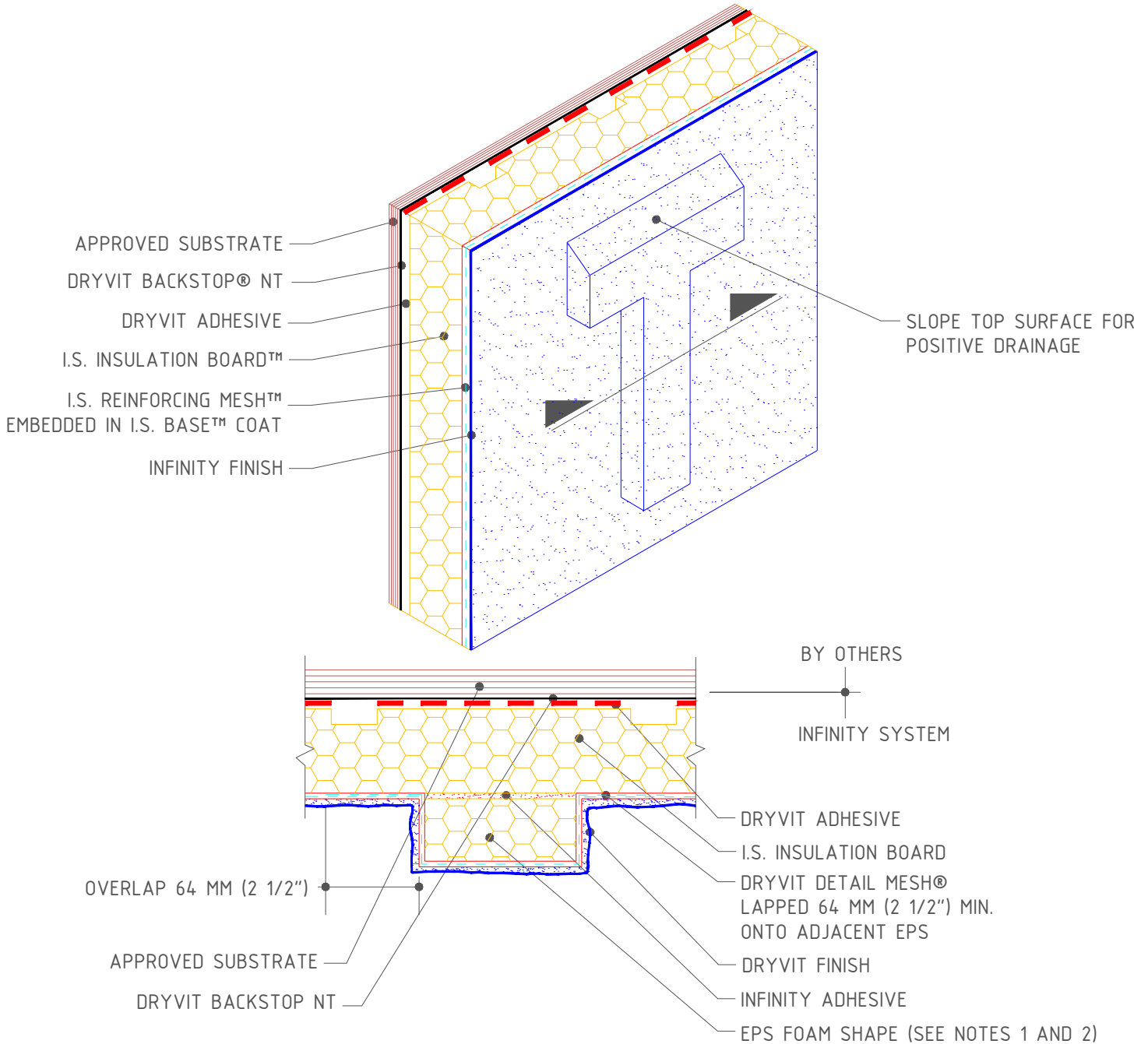

## INFINITY® SYSTEM

## Projecting Graphics

**NOTE:**

1. MAXIMUM THICKNESS OF EPS BUILT OUT SHAPES SHALL NOT EXCEED 305 MM (12 INCHES) AT ANY POINT MEASURED FROM THE SUBSTRATE.
2. PERCENTAGE OF WALL AREA COVERED BY EPS FOAM SHAPES IN EXCESS OF 102 MM (4 IN) IN THICKNESS SHALL NOT EXCEED 15%.

The architecture, engineering and design of the project using the Dryvit products is the responsibility of the project's design professional. All systems must comply with local building codes and standards. This detail is for general information and guidance only and Dryvit specifically disclaims any liability for the use of this detail and for the architecture, design, engineering or workmanship of any project. The project design professional determines, in its sole discretion, whether this detail or a functionally equivalent alternative is best suited for the project. Use of a functionally equivalent detail does not violate Dryvit's warranty. This detail is subject to change without notice. Contact Dryvit to insure you have the most recent version.

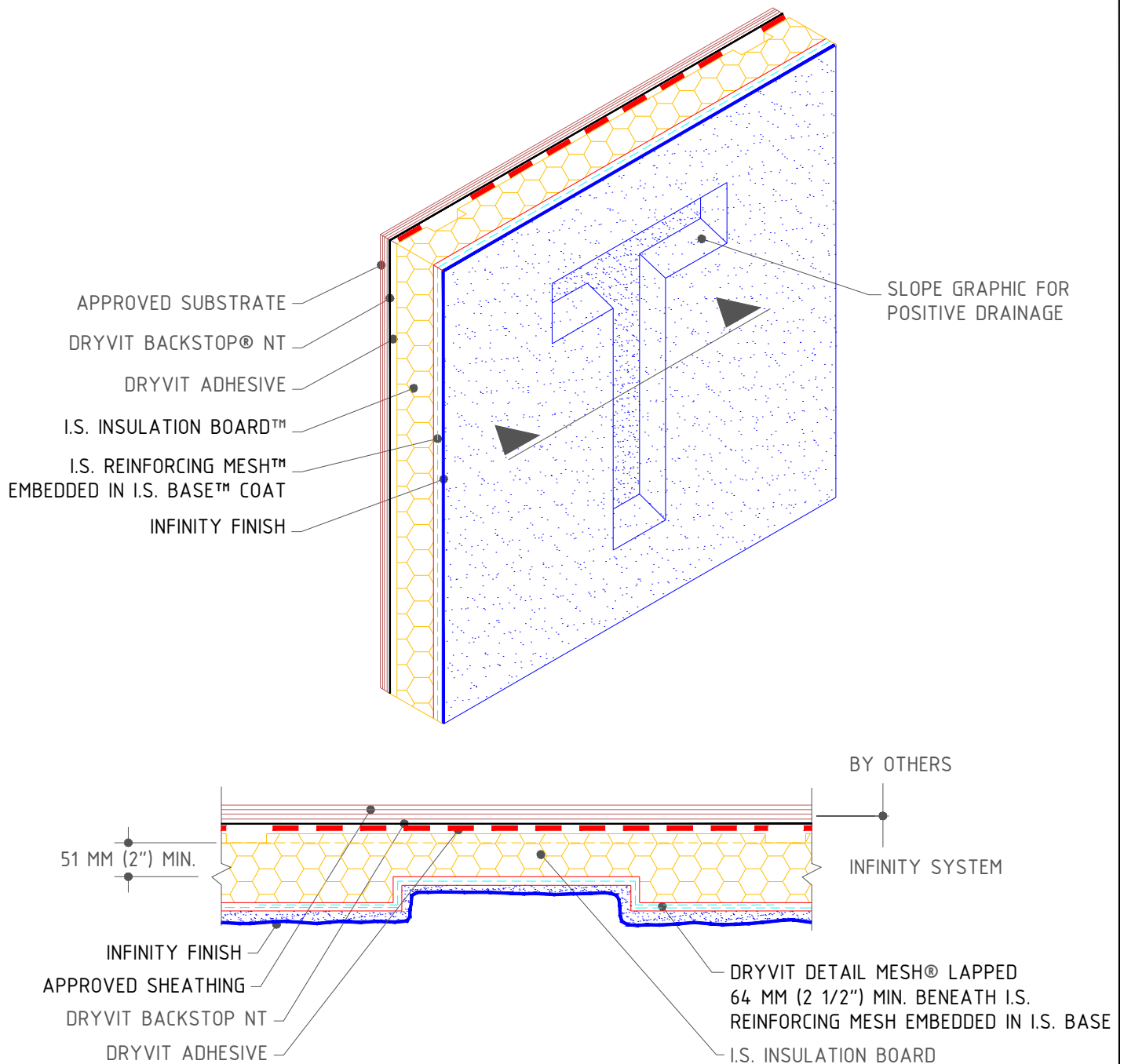

## INFINITY® SYSTEM

### Recessed Graphics

The architecture, engineering and design of the project using the Dryvit products is the responsibility of the project's design professional. All systems must comply with local building codes and standards. This detail is for general information and guidance only and Dryvit specifically disclaims any liability for the use of this detail and for the architecture, design, engineering or workmanship of any project. The project design professional determines, in its sole discretion, whether this detail or a functionally equivalent alternative is best suited for the project. Use of a functionally equivalent detail does not violate Dryvit's warranty. This detail is subject to change without notice. Contact Dryvit to insure you have the most recent version.



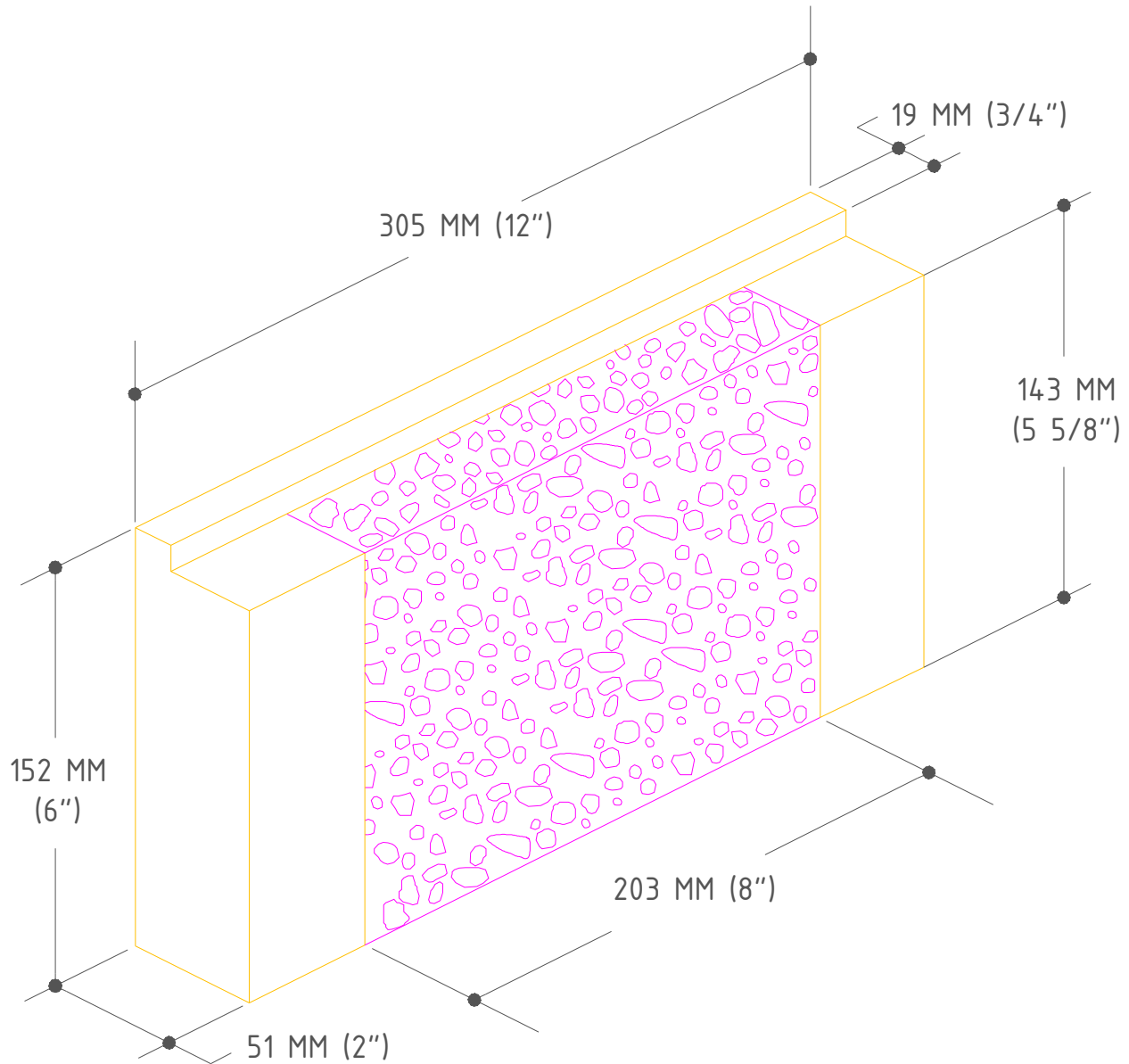

## INFINITY<sup>®</sup> SYSTEM

### Dryvit Vent Assembly<sup>™</sup>

The architecture, engineering and design of the project using the Dryvit products is the responsibility of the project's design professional. All systems must comply with local building codes and standards. This detail is for general information and guidance only and Dryvit specifically disclaims any liability for the use of this detail and for the architecture, design, engineering or workmanship of any project. The project design professional determines, in its sole discretion, whether this detail or a functionally equivalent alternative is best suited for the project. Use of a functionally equivalent detail does not violate Dryvit's warranty. This detail is subject to change without notice. Contact Dryvit to insure you have the most recent version.

